



— Stock Code: 688026 —

YOUR RELIABLE PARTNER IN LIFE SCIENCE

Jet Biofil Online Platforms

Scan the QR codes below to follow Jet Biofil on our social media platforms, promptly receiving more company updates, industry news, product information, product application tips, event details.



Official Website



LinkedIn



WeChat Video Acc



Youtube



— Stock Code: 688026 —

Guangzhou Jet Bio-Filtration Co.,Ltd.

Address: No.1 DouTang Road, YongHe Development Zone, Guangzhou, 511356,China
Contact Hotline: +86-400-8717-688
Before-sale service: info@jetbiofil.com
After-sale service: info@jetbiofil.com

• JET · Europe Office

Jet Life Science GmbH
Boschring 20, 56422 Wirges, Germany
Tel: (+49) 151 534 90797
E-mail: stephan@jetbiofil.com

• JET · Korea Office

DAIHAN Bldg.,24-4, Sangwolgok-dong,Seongbuk-gu,
Seoul,Korea
Tel: +82-80-008-3000 Fax:+82-33-737-7509
E-mail: chloe.baek@daihan-sci.com

• JET · Australia Office

11 Challenge Boulevard, Wangara WA 6065 Australia
Tel: +61 8 9302 1911
E-mail: rowewa@rowe.com.au

• JET · Israel Office

18 Soreq St. Emek Sara 8400795,
Beer-sheva, Israel
Tel: 972-86280210 Fax:972-8-6280801
E-mail: info@romical.com

• JET · South America Office

Gral. Alvear 123, 1° Of. 5 Lomas de Zamora (B1832BVC),
Buenos Aires, Argentina
Tel: (+5411) 42921611
E-mail: info@apbiotech.com.ar www.apbiotech.com.ar

• JET · US Office

1551 South Acottsdale Court Suirt 200,Elgin IL,60123
Tel: 847-622-0456
E-mail: pkne007@aol.com

• JET · Japan Office

Manshon Omiya 206, Mibuaiai-cho 32,
Nakagyo-ku, Kyoto 604-8812, Japan
Tel:+81-75-334-6282 Fax:+81-75-822-2194
E-mail:kooki@jc5.so-net.ne.jp



2024

CATALOGUE

Guangzhou Jet Bio-Filtration Co.,Ltd.



Jet Biofil Achieves Bronze Ranking in EcoVadis Sustainability Assessment

-- To Lead in Sustainable Development

- Top 34% of all involved enterprises in the evaluation of Four Themes



Crafting Excellence Since 2001

Guangzhou Jet Bio-Filtration Co., Ltd.

Guangzhou Jet Bio-Filtration Co., Ltd. (stock code: 688026), founded in 2001 and located in Huangpu District of Guangzhou City, is a domestic leading high-tech enterprise that offers total solutions for biological laboratories. The company covers an overall floorage of up to 160,000 m² and has more than 65,000 m² of GMP Cleanrooms. Thousands of the company's products such as high-end consumables, biological laboratories reagents and laboratory instruments that have been widely used in more than 70 countries and regions. The company owns several core technologies and advanced production processes for biological laboratory consumables and has been successfully selected into the global supply chain system for world-famous service providers of biological laboratory materials, by virtue of excellent technical performance, product quality and efficient service.

The company upholds an innovative spirit and focuses on strengthening the research and development of core technologies. Until recently, the company holds 185 patents, including 34 invention patents currently, and has received the National Invention Patent Award for four consecutive years. Jet Biofil has led the formulation of two provincial standards, 24 group standards, and participated in the development of three industry standards.

On October 24, 2018, Guangzhou Jet Bio-Filtration Co., Ltd. was honorably inspected by General Secretary Xi Jinping on behalf of private enterprises.

2001
Established since

160,000m²
Floor Area

65,000m²
Cleanrooms

7,000+
Product SKUs

70+
Countries and Regions

205+
Patents

30+
Standards

History

2022-present

Committed to making great achievements with great ambition

- A new plant with an area of 160,000m² in Huangpu District of Guangzhou was put into use
- Grand commencement of Jet Life Science (Guangzhou) intelligent manufacturing and storage project



2020-2021

Go forward with honor

- Awarded the title of "an important contributor to the material support work of COVID-19 epidemic prevention and control in Guangdong Province"
- Awarded the title of "private enterprise with outstanding contribution in fighting COVID-19 in Guangzhou"
- Included in the "little giant" list of national specialized, sophisticated and characteristic enterprises by the Ministry of Industry and Information Technology of the People's Republic of China



2020

Reach new heights

- Successfully listed on the Science and Technology Innovation Board of Shanghai Stock Exchange



2018

Attract worldwide attention

- Mr. Yuan Jianhua, Chairman of the company, was received by the General Secretary Xi as a representative of private entrepreneurs



2013-2018

Score big points

- Became the first batch of Guangzhou Development Zone pilot units of science and technology enterprise incubator
- Recognized as "Guangdong Engineering Technology Research Center for Disposable Biological Laboratory Supplies"
- The company's R&D center was recognized as the provincial enterprise technology center

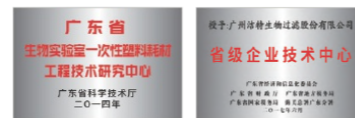

2007

Gradually stand out

- The company received ISO9001/13485 certification

2001-2003

Fledgling

- Guangzhou Jet Bio-Filtration Co., Ltd. was established
- The first product was successfully developed by using high polymer material modification technology



Quality Assurances

Over the past two decades, we have implemented multiple measures to ensure consistent product quality:

- ✓ Careful product design and precision manufacturing
- ✓ Selection of raw materials in accordance with USP Class VI standards
- ✓ High automation production in a cleanroom environment with a class 100,000 rating
- ✓ Certification compliance with ISO 13485/ISO 9001/ISO 14001 standards
- ✓ FDA-approved enterprise (Registration number: 3011966385)
- ✓ Multiple CE certifications in the EU
- ✓ Laboratory accreditation through CNAS
- ✓ Possession of a medical device production license
- ✓ Each product's minimum packaging is labeled with a batch number, facilitating accurate quality traceability



License of Medical Device Production



ISO 9001

ISO 13485



ISO 14001



FDA



CE



CNAS



GMP Certified

Quality Benchmarks

To ensure that your research attains the highest level of repeatability and reliability, our product quality undergoes continuous upgrades.



- ✓ Sterile
Complies with ISO 11137 standards, Sterility Assurance Level (SAL) < 10⁻⁶
- ✓ Pyrogen-free/Endotoxin-free
<0.03EU/mL
- ✓ DNase-free
<1x10⁻⁶ Kunitz units
- ✓ PCR Inhibitor-free
≤ 2 cycle shifts
- ✓ Human DNA-free
<0.03pg/μL
- ✓ RNase-free
<1x10⁻⁶ Kunitz units
- ✓ ATP-free
<2x10⁻¹² mg/μL

Total 490,000 square meters of intelligent-upgraded manufacturing plants



More than 65,000 m² of GMP Cleanrooms

Establishing a scientific and rigorous aseptic production environment is crucial to ensure the high purity of our manufactured products

Huangpu Manufacturing Center: 160,000m²

- GMP Cleanrooms: more than 65,000m²
- Intelligent manufacturing model workshops: 15,000m²
- CNAS-accredited cleanroom testing center: 3,000m²

The facility is equipped with state-of-the-art automated production equipment and has implemented an Information Technology-based Manufacturing Execution System (MES). This comprehensive approach enables unmanned production, positioning our facility as an industry-leading smart factory and benchmark facility.

Zengcheng Intelligent Manufacturing Project: 330,000m²

The new establishing plant in Zengcheng District has a total construction area of 330,000m². Construction commenced in 2022. It is positioned to become a leading intelligent manufacturing and integrated warehousing project in the industry. The project plan includes key facilities such as a research and development building, GMP workshops, a sterilizing center, and a three-dimensional warehouse.



Automation with MES Intelligent Control

Equipped with top-notch automation equipment and introducing MES intelligent management systems, achieving comprehensive high automation production and intelligent control. Achieving minimum human-machine interaction, limiting the adverse effects of particles, oil contamination, special processes, air disturbances, heat dissipation, thereby ensuring high consistency and stability in product quality.



CNAS-accredited cleanroom testing center: 3,000 m²

Jet Testing Technology Service is an independently operated third-party testing institution. By equipping itself with industry-leading testing equipment and assembling a professional technical team composed of over 70% doctoral and master's degree holders, it strictly adheres to ISO 17025 standards in management and operations. This enables Jet Testing to provide more professional and comprehensive authoritative testing services for biological laboratory consumables.





Global Business, Dedicated Service

Transnational Business

With outstanding technical performance, product quality, and efficient service, Jet Biofil's products are exported to over 70 countries and regions. We have developed long-term, friendly cooperative relationships with customers, including some of the world's top 500 companies in the field of life sciences.

Domestic Business

Jet Biofil's domestic business outlets span across the entire country, with 12 offices established in key cities including Beijing, Xi'an, Changchun, Tianjin, Shanghai, Wuhan, Nanjing, Hangzhou, Guangzhou, Shenzhen, Chengdu, and Chongqing.

Automated Storage and Retrieval System (AS/RS) Warehouse Management System (WMS)

To passionately build a more efficient and convenient warehousing and logistics delivery service, Jet Biofil has implemented an Automated Storage and Retrieval System (AS/RS), established over a hundred intelligent storage and logistics distribution points, and introduced a smart Warehouse Managed System (WMS). Resulted in the development of a comprehensive, data-driven, and intelligent international and domestic logistics system owned by Jet Biofil, allowing for maximum coverage of goods and highly efficient allocation and catering to the needs of every customer.



Contents

Cell Culture

- Cell and Tissue Culture Flasks - - - - - 7
- Cell and Tissue Culture Dishes - - - - - 9
- Cell and Tissue Culture Plates - - - - - 11
- 96 Well Detachable Flat Plates - - - - - 13
- CellATTACH® Cell and Tissue Culture Products - - - - - 14
- CellDETACH™ Temperature-Responsive Cell Culture Surface - - - - - 15
- 3DSphero™ Ultra-low Adsorption Surface - - - - - 17
- Tissue Culture Plate Inserts - - - - - 18
- 100 mm Tissue Culture Dish Insert - - - - - 20
- Confocal Dishes - - - - - 21
- CellSLIP® Coverslips - - - - - 22
- CellSCAFLD® 3D Cell Culture Scaffolds - - - - - 23
- Bio-Reaction Tubes - - - - - 25
- Culture Tubes - - - - - 26
- 15 mL PS Centrifuge Tubes - - - - - 27
- Cell Strainers - - - - - 28
- Pestles for Cell Strainer - - - - - 29
- Pestles for 1.5mL Micro Centrifuge Tube - - - - - 30
- Cell Scrapers/Rotatable Cell Scrapers - - - - - 30
- Exchangeable Cell Blade and Lifters - - - - - 32
- L-shaped Cell Spreaders - - - - - 32
- Cryogenic Vials - - - - - 33

Bioprocess

- CellFac® Multi-Layer Cell Culture Systems - - - - - 41
- Erlenmeyer Flasks - - - - - 44
- Large-capacity Erlenmeyer Flasks - - - - - 45
- Closed System for Erlenmeyer Flasks - - - - - 46
- Multi-layer Cell Culture Flasks - - - - - 48
- Roller Bottles - - - - - 49

Liquid Handling and Storage

- Centrifuge Tubes - - - - - 52
- Conical Centrifuge Bottles - - - - - 54
- High-Performance Centrifuge Tubes - - - - - 55
- Light Sensitive Centrifuge Tubes - - - - - 55
- High RCF Centrifuge Tubes - - - - - 56
- 15 mL Centrifuge Tubes with Puncture Hole - - - - - 57
- Metal-Free Centrifuge Tubes - - - - - 57
- EasyFlip™ Centrifuge Tubes - - - - - 58
- 30 mL Self-standing Centrifuge Tubes - - - - - 59
- Plastic Centrifuge Tube Racks - - - - - 60
- Centrifuge Tube Stands - - - - - 61
- Serum & Sample Tubes - - - - - 62
- Plastic Pasteur Pipets - - - - - 63
- Serological Pipets - - - - - 64
- Open End Pipets - - - - - 67
- Mini™ Serological Pipets - - - - - 68
- Aspirating Pipets - - - - - 68
- Milk Pipets - - - - - 69
- Disposable Sampling Tubes - - - - - 70
- Transfer Pipets - - - - - 71
- Square Media Bottles - - - - - 72
- Solution Bottles - - - - - 73

Filtration

- Syringe Filters - - - - - 75

- 50 mm Syringe Filters - - - - - 79
- 50 mm Sterilizing Filters - - - - - 80
- Vacuum Bottle Filters - - - - - 81
- Filter Upper Cups - - - - - 84
- Reservoir Bottles - - - - - 86
- Tube Vacuum Filters System - - - - - 87
- Tube Top Vacuum Filters - - - - - 88
- JetSpin® Centrifugal Filters - - - - - 89

Molecular Biology

- Pipette Micro Tips - - - - - 92
- ZEROTIP® Pipette Micro Tips - - - - - 97
- Robotic Tips - - - - - 100
- Micro Centrifuge Tubes - - - - - 105
- Lid Lock Micro Centrifuge Tubes - - - - - 107
- EasyFlip™ 1.5mL Micro Centrifuge Tubes - - - - - 109
- Low Binding Microcentrifuge Tubes (Lo-Protein™/Lo-DNA™) - - - - - 110
- Deep-well Plates - - - - - 112
- Sample Library Tubes - - - - - 114
- PCR Plates - - - - - 116
- PCR Tubes - - - - - 117
- PCR Plate Sealing Film - - - - - 119
- Reagent Reservoirs(PP) - - - - - 120
- Reagent Reservoirs(PET/PS) - - - - - 121
- 12-Channel Reagent Reservoir - - - - - 122

CellSafe™ GMP-grade Life Science Consumables

- CellSafe™ GMP-grade Life Science Consumables - - - - - 124
- CellSafe™ Peripheral Blood Separation Tube - - - - - 127

Specialized Consumables for Assist Reproduction (Medical Devices)

- 129

Others

- ELISA Plates - - - - - 133
- Immuno Micro Plates - - - - - 135
- Petri Dishes - - - - - 136
- Inoculating Loops and Needles - - - - - 137
- Cuvettes - - - - - 138
- Graduated Urine Centrifuge Tubes - - - - - 138
- Latex powder-free gloves - - - - - 139
- NBR Gloves - - - - - 140
- Disposable Virus Sampling Tubes - - - - - 140

Biological Reagent

- Fetal Bovine Serum - - - - - 143
- Media - - - - - 145
- Insect Media - - - - - 146
- Supplementary Reagents - - - - - 147

Laboratory Equipment

- JetPip™ Plus - - - - - 152
- JetPip™ Pipette Controller - - - - - 152
- Multichannel Micro Pipettors - - - - - 153
- Micro Volume Pipettors - - - - - 154



Stock Code: 688026

Cell Culture Products



With numerous international agree leading key core technologies and advanced production processes for laboratory consumables, JET BIOFIL has consistently produced high-quality cell culture products over the more than two decades to ensure agree the best repeatability and the most reliable results in studies, and our products are therefore widely used by researchers. Dozens of surfaces of culture vessels ranging from 0.1135 cm² to 6,416 cm², the cell culture products of JET BIOFIL are suitable for most applications and can meet your different demands for cell culture. Our products are DNase/RNase, pyrogen-free, and non-cytotoxic. They are made of high-quality raw materials that conform to USP Class VI standards and are produced in a Class 100,000 clean workshop in strict accordance with ISO 9001:2015 and ISO 13485:2016. All products have undergone cell line testing and strict quality validation, and they have consistently showed stable performance. These products mainly include cell and tissue culture flasks, cell and tissue culture dishes, cell and tissue culture plates and other products.

Cell and Tissue Culture Flasks

Cell and tissue culture flasks are the most suitable culture vessels for long-term and large-scale laboratory cell culture while preventing contamination. The surface untreated flasks are suitable for suspension cells culture, while those with a TC-treated surface are suitable for common adherent cell lines due to the excellent hydrophilicity of the polystyrene surface. The CellATTACH[®] superhydrophilic treated surface represents a technical advancement that improves the adhesion and growth of difficult-to-nourish cells, primary cells and transfection cell lines under low serum/serum-free conditions.

- Specification: T12.5 T25 T75 T150 T175 T182 T225 T300
- Type of Cap: Plug Seal Vent
- Surface: Non-treated TC-treated CellATTACH[®]-treated

- Materials: Flask Body: Polystyrene (PS)
Bottle Cap: High-density Polyethylene (HDPE)
Filter Membrane: Polytetrafluoroethylene (PTFE), conforming to USP Class VI standards

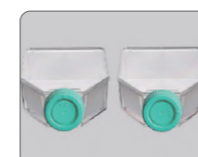

Ergonomic cap design-open/close by rotating 1/4 of its full range.



Clear graduations are shown on both sides and the frosted area can be marked.



The tilted bottleneck facilitates liquid pouring, as well as convenient operations of pipettes and cell scrapers.



0.22 µm PTFE hydrophobic vent cap supports gas exchange and prevents cross-contamination.

Features

- Various treated surfaces are suitable for different culture needs
- The hydrophobic vent cap ensures continuous ventilation, enabled by turning the cap 1/4 of its full range
- The tilted bottleneck facilitates easy access of pipets and cell scrapers
- Low profile design supports effective use of the internal space of the incubator when stacked
- The frosted area near the bottleneck can be written on
- Volume graduations molded on both sides
- 100% tested for production line leakage
- Lot No. on the bottom of each flask and package bag for quality traceability
- Sterilized by irradiation, SAL 10⁻⁶
- DNase/RNase-free, non-pyrogenic and non-cytotoxic

Cell and Tissue Culture Flasks, Non-treated

Cat. No.	Volume (mL)	Cell Culture Surface Area (cm ²)	Maximum Working Volume (mL)	Type of Cap	Dimensions(mm)				Sterile	Qty. Per Bag	Qty. Per Case
					L	W	H	B.N.D*			
TCF001025	25	12.5	8	Plug Seal	73.71	40.38	22.79	14.15	Y	10	200
TCF002025	25	12.5	8	Vent	73.71	40.38	22.79	14.15	Y	10	200
TCF001050	50	25.0	17.5	Plug Seal	92.88	49.5	29.08	18.2	Y	10	200
TCF002050	50	25.0	17.5	Vent	92.88	49.5	29.08	18.2	Y	10	200
TCF001250	250	75.0	60	Plug Seal	152.52	81.54	35.21	25	Y	5	100
TCF002250	250	75.0	60	Vent	152.52	81.54	35.21	25	Y	5	100
TCF001150	30-375	150.0 (U-shaped)	140	Plug Seal	199.7	111.3	111.3	25.6	Y	5	50
TCF002150	30-375	150.0 (U-shaped)	140	Vent	199.7	111.3	111.3	25.6	Y	5	50
TCF001175	50-600	175.0	250	Plug Seal	199.9	122.7	49.2	25.7	Y	5	50
TCF002175	50-600	175.0	250	Vent	199.9	122.7	49.2	25.7	Y	5	50
TCF001600	600	182.0	125	Plug Seal	219.28	115.74	38.3	29.5	Y	5	40
TCF002600	600	182.0	125	Vent	219.28	115.74	38.3	29.5	Y	5	40
TCF101600	600	182.0 (Extended)	200	Plug Seal	219.28	115.74	49.5	29.5	Y	5	40
TCF102600	600	182.0 (Extended)	200	Vent	219.28	115.74	49.5	29.5	Y	5	40
TCF001225	850	225.0	400	Plug Seal	221.9	137.2	49.5	25.65	Y	5	25
TCF002225	850	225.0	400	Vent	221.9	137.2	49.5	25.65	Y	5	25
TCF001850	850	300.0	200	Plug Seal	269.15	166	47	29.5	Y	3	18
TCF002850	850	300.0	200	Vent	269.15	166	47	29.5	Y	3	18

* Bottle Neck Diameter

Cell and Tissue Culture Flasks, TC-treated

Cat. No.	Volume (mL)	Recommended Working Volume (mL)	Cell Culture Surface Area (cm ²)	Maximum Working Volume (mL)	Type of Cap	Dimensions(mm)				Sterile	Qty. Per Bag	Qty. Per Case
						L	W	H	B.N.D*			
TCF011025	25	2.5-3.75	12.5	8	Plug Seal	73.71	40.38	22.79	14.15	Y	10	200
TCF012025	25	2.5-3.75	12.5	8	Vent	73.71	40.38	22.79	14.15	Y	10	200
TCF011050	50	5-7.5	25.0	17.5	Plug Seal	92.88	49.5	29.08	18.2	Y	10	200
TCF012050	50	5-7.5	25.0	17.5	Vent	92.88	49.5	29.08	18.2	Y	10	200
TCF011250	250	15-22.5	75.0	60	Plug Seal	152.52	81.54	35.21	25	Y	5	100
TCF012250	250	15-22.5	75.0	60	Vent	152.52	81.54	35.21	25	Y	5	100
TCF011150	30-375	30-45	150.0 (U-shaped)	140	Plug Seal	199.7	111.3	111.3	25.6	Y	5	50
TCF022150	30-375	30-45	150.0 (U-shaped)	140	Vent	199.7	111.3	111.3	25.6	Y	5	50
TCF011175	50-600	35-52.5	175.0	250	Plug Seal	199.9	122.7	49.2	25.7	Y	5	50
TCF012175	50-600	35-52.5	175.0	250	Vent	199.9	122.7	49.2	25.7	Y	5	50
TCF011600	600	36.4-54.6	182.0	125	Plug Seal	219.28	115.74	38.3	29.5	Y	5	40
TCF012600	600	36.4-54.6	182.0	125	Vent	219.28	115.74	38.3	29.5	Y	5	40
TCF111600	600	36.4-54.6	182.0 (Extended)	200	Plug Seal	219.28	115.74	49.5	29.5	Y	5	40
TCF112600	600	36.4-54.6	182.0 (Extended)	200	Vent	219.28	115.74	49.5	29.5	Y	5	40
TCF011225	850	60-90	225.0	400	Plug Seal	221.9	137.2	49.5	25.65	Y	5	25
TCF012225	850	60-90	225.0	400	Vent	221.9	137.2	49.5	25.65	Y	5	25
TCF011850	850	60-90	300.0	200	Plug Seal	269.15	166	47	29.5	Y	3	18
TCF012850	850	60-90	300.0	200	Vent	269.15	166	47	29.5	Y	3	18

* Bottle Neck Diameter

Cell and Tissue Culture Dishes

Cell and tissue culture dishes can be used for culturing plants, animal cells, and microbes. The non-treated surface dishes are suitable for suspension cell cultures, while those with the TC-treated surface are suitable for common adherent cell lines due to the excellent hydrophilicity of the polystyrene surface. The CellATTACH® superhydrophilic treated surface represents a technical advancement that improves the adhesion and growth of fastidious cells, primary cells and transfection cell lines under low serum/serum-free conditions.

- ◎ Specification: 35 mm 60 mm 70 mm 90 mm 100 mm 150 mm
- ◎ Surface: Non-treated TC-treated CellATTACH®-treated
- ◎ Materials: Polystyrene (PS), conforming to USP Class VI standards



The gripping ring is designed for easy grip when wearing gloves, ensuring that the culture dish cover will not move during processing, thus reducing the risk of contamination.



The outer edge of the culture dish cap is slightly convex to ensure stable stacking.

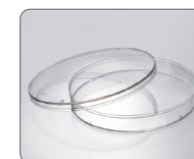

The edge brackets on the lid's inwall ensures both sterility and air ventilation.



The positioning markers at the bottom of the culture dish facilitate the positioning of cells.

Features

- Various treated surfaces are suitable for different culture needs
- The gear ring design on the side makes it easier to hold and reduces contamination.
- The ring-shaped protrusion on the lid fits perfectly with the bottom of the dish to facilitate stacking of culture dishes
- The notched design of the lid ensures sterility and gas exchange
- The sterile ziplock packaging enables repeated sealing
- Sterilized by irradiation, SAL 10⁻⁶
- DNase/RNase-free, non-pyrogenic and non-cytotoxic

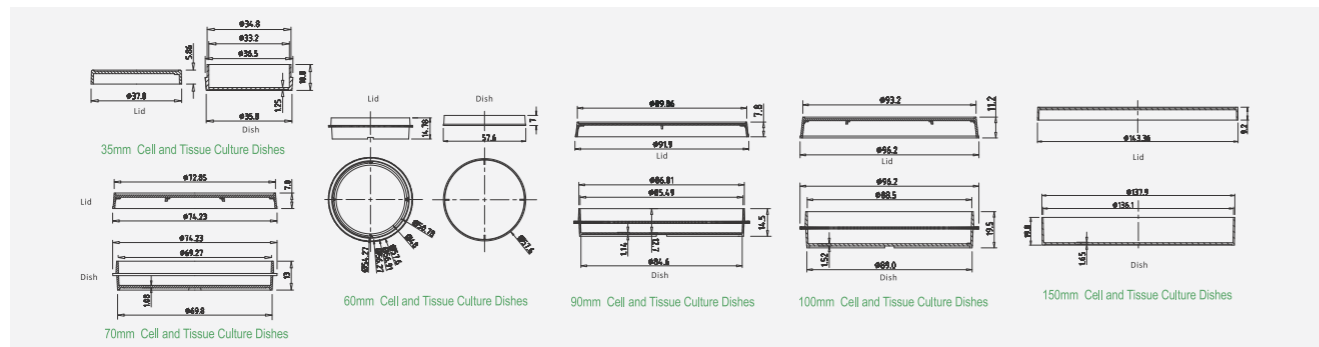

Cell and Tissue Culture Dishes, Non-treated

Cat. No.	Diameter(mm)	Height(mm)	Culture Area (cm ²)	Recommended Working Volume (mL)	Qty. Per Bag	Qty. Per Case
TCD000018	18	12.1	1.41	-	10	300
TCD000035	35	12.6	8.5	2-3.5	10	960
TCD000060	60	17.3	21.2	4-7	10	600
TCD100060	60 (Center Well)	16.0	/	4-7	10	600
TCD000070	70	15.5	36.3	6-11	10	600
TCD000090	90	16.9	55	10-18	10	500
TCD000100	100	22.6	60.8	12-20	10	300
TCD000150	150	22.7	143	25-50	1	120

Cell and Tissue Culture Dishes, with TC-treated

Cat. No.	Diameter(mm)	Height(mm)	Culture Area (cm ²)	Recommended Working Volume (mL)	Qty. Per Bag	Qty. Per Case
TCD010018	18	12.1	1.41	-	10	300
TCD010035	35	12.6	8.5	2-3.5	10	960
TCD010060	60	17.3	21.2	4-7	10	600
TCD110060	60 (Center Well)	16.0	/	4-7	10	600
TCD010070	70	15.5	36.3	6-11	10	600
TCD010090	90	16.9	55	10-18	10	500
TCD010100	100	22.6	60.8	12-20	10	300
TCD010150	150	22.7	143	25-50	1	120
TCD110150	150	22.7	143	25-50	5	100

Height: total height that combines cap and dish

Cell and Tissue Culture Plates

We supply premium cell culture plates with a range of specifications and surfaces for experimental research, optimization and analysis to deliver the best outcomes for cell culture and subsequent cell assays, such as cell transfection, immunofluorescence, and clone formation. Assisting with experimental research, optimization and analysis. Surface-untreated plates are suitable for suspension cell cultures, and those with a TC-treated surface are suitable for common adherent cell lines due to the excellent hydrophilicity of the polystyrene surface. The CellATTACH® superhydrophilic treated surface represents a technical advancement that OR and allows better adhesion and proliferation of fastidious cells as well as primary or transfected cell lines under low serum/serum-free conditions.

- Specification: Single well 4-well 6-well 12-well 24-well 48-well 96-well 384-well
- Surface: Non-treated TC-treated CellATTACH®-treated
- Packaging: Blister pack
- Bottom type: Flat U-shaped
- Materials: Polystyrene (PS), conforming to USP Class VI standards

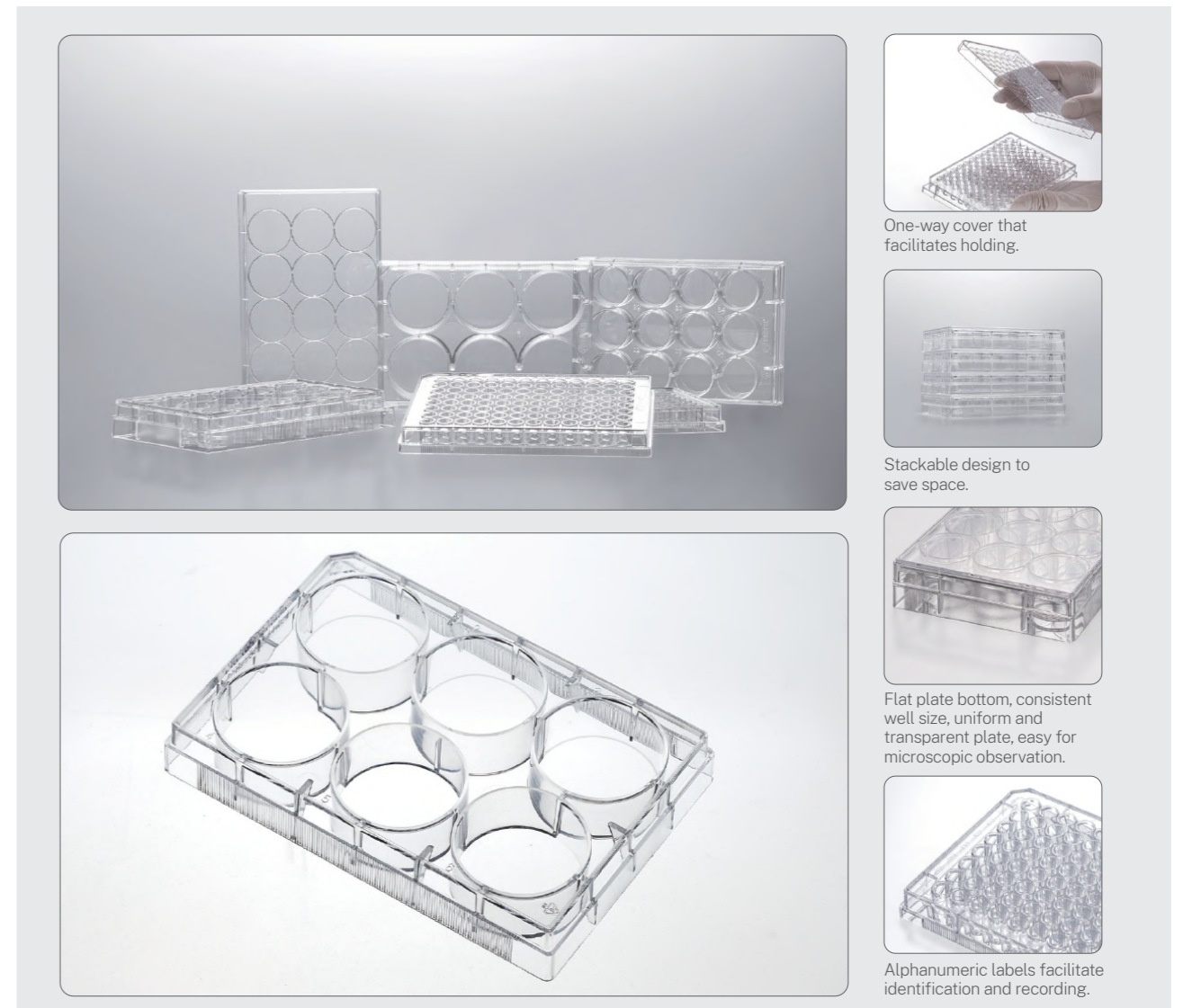

One-way cover that facilitates holding.

Stackable design to save space.

Flat plate bottom, consistent well size, uniform and transparent plate, easy for microscopic observation.

Alphanumeric labels facilitate identification and recording.

Features

- Uniform thickness of plate bottom and well size.
- Plates with U-shaped bottom are suitable for suspension culture, chemical and analytical experiment, or sample preservation. The detachable 96-well plate is suitable for experimental analysis.
- Transparent material facilitates observation under a microscope.
- Plate cover and plate body fit tightly, thus reducing contamination of the medium or evaporation loss during the cell culture process.
- The ergonomically designed one-way cover can be held easily, reducing mistakes.
- The well edge design prevents cross-contamination, with alphanumeric markers to facilitate identification and marking.
- Stackable-space saving and compatible with most multi-well plate instruments and equipment.
- Lot No. printed at the sides of the plate and package bag facilitates quality traceability.
- Sterilized by irradiation, SAL 10⁻⁶
- DNase/RNase-free, non-pyrogenic and non-cytotoxic

Cell and Tissue Culture Plates , Non-treated , in Blister Box

Cat . No .	Surface Type	Specification (Well)	Well Type	Max . Working Volume of a Single Well (mL)	Qty. Per Bag	Qty. Per Case
TCP001001	Non-treated	Single well	Flat	90	1	100
TCP001004	Non-treated	4	Flat	1.86	1	100
TCP001006	Non-treated	6	Flat	17.0	1	100
TCP001012	Non-treated	12	Flat	6.80	1	100
TCP001024	Non-treated	24	Flat	3.50	1	100
TCP001048	Non-treated	48	Flat	1.55	1	100
TCP001096	Non-treated	96	Flat	0.39	1	100
TCP002096	Non-treated	96	U-shaped	0.33	1	100
TCP001384	Non-treated	384	Flat	0.145	1	100

Cell and Tissue Culture Plates, with TC-Treated, in Blister Box

Cat . No .	Surface Type	Specification (Well)	Well Type	Max . Working Volume of a Single Well (mL)	Recommended Working Volume of a Single Well (mL)	Culture Area of a Single Well (cm ²)	Qty. Per Bag	Qty. Per Case
TCP011001	TC-treated	Single well	Flat	90	35.0	97	1	100
TCP011004	TC-treated	4	Flat	1.86	0.39-0.59	1.96	1	100
TCP011006	TC-treated	6	Flat	17.0	1.9-2.9	9.6	1	100
TCP011012	TC-treated	12	Flat	6.80	0.76-1.14	3.85	1	100
TCP011024	TC-treated	24	Flat	3.50	0.38-0.57	1.93	1	100
TCP011048	TC-treated	48	Flat	1.55	0.19-0.29	0.84	1	100
TCP011096	TC-treated	96	Flat	0.39	0.075-0.2	0.33	1	100
TCP012096	TC-treated	96	U-shaped	0.33	0.075-0.2	0.58	1	100
TCP011384	TC-treated	384	Flat	0.145	0.01-0.1	0.1135	1	100

96-well Detachable Flat Plates

The 96-well detachable flat plates can be used to explore, optimize and analyze experimental conditions for cell cultures, and can meet the needs of a wide variety of experiments. There are two different surfaces available. The non-treated surface is suitable for suspension cell cultures, while the TC-treated surface is suitable for adhesion and spreading of common cell lines.

- Specification: 96-well detachable (with 8-well strips)
- Bottom type: Flat bottom
- Surface: Non-treated TC-treated
- Packaging: Blister pack
- Materials: Strip: Polystyrene (PS)
Plate frame: High impact polystyrene (HIPS), conforming to USP Class VI standards.



Features

- Uniform thickness of the bottom of the plate, smooth and clean, free of deformation, with a uniform well size
- The plate is transparent with excellent optical properties and is easy to observe under a microscope
- Detachable 8-well strips, suitable for a large variety of experiments
- Unique one-way cover design for easy identification ensures operational consistency
- Clear alphanumeric labels that are easy to distinguish and identify, and allows for easy recording
- Hole edge design to prevent cross contamination, non-slip and easy to hold, with a minimized contact area
- Can be stacked for space-saving purposes and for better compatibility
- Sterilized by irradiation, SAL 10⁻⁶
- DNase/RNase-free, non-pyrogenic, non-cytotoxic

96-well Detachable Flat Plates

Cat. No.	Description	Qty. Per Bag	Qty. Per Case
TCP011896	8-well x 12 strips, Standard, TC-treated, Sterile	1	100
TCP001896	8-well x 12 strips, General, Non-treated, Sterile	1	100

CellATTACH® Cell and Tissue Culture Products

The CellATTACH® superhydrophilic cell culture product series is created by introducing polar groups onto their surfaces. This forms a durable and stable superhydrophilic surface that facilitates good adherent growth of various types of cells under different culture conditions, thereby improving cell yield. The treated surface also eliminates the need for unstable, time-consuming, and costly biological coating.

- Cell and Tissue Culture Flasks: T12.5 T25 T75 T182 T225 T300 Cap Style: Plug Seal Vent
- Cell and Tissue Culture Plates: 6-well 12-well 24-well 48-well 96-well
- Cell and Tissue Culture Dishes: 35 mm 60 mm 70 mm 90 mm 100 mm 150 mm
- Materials: Flask/Plate/Dish Body: Polystyrene (PS), Flask Cap: High-density Polyethylene (HDPE),
Filter Membrane: Polytetrafluoroethylene (PTFE), conforming to USP Class VI standards

Features

- Unique superhydrophilic surface treatment technology provides better adherence for cells, promoting rapid cell growth and increasing yields.
- This ensures continuous and uniform cell adherence, and can be used for adherent cultures of primary cells, neuronal cells, stem cells and other fastidious cells that have more stringent requirements for the hydrophilicity of the culture surface.
- Cells can adapt quickly to a serum-free or low-serum culture environment, meeting the needs of experiments that require the elimination of interference by serum components or that require reduced serum levels, thus reducing the cost of cell culture.

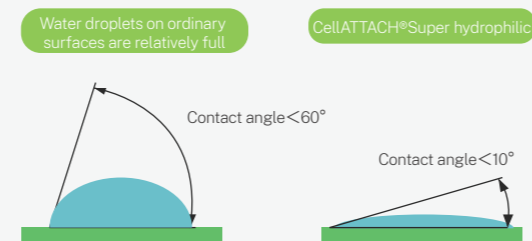

CellATTACH® Cell and Tissue Culture Flasks

Cat. No.	Volume (mL)	Cell Culture Surface Area (cm ²)	Recommended Working Volume (mL)	Maximum Working Volume (mL)	Cap Style	Dimensions(mm)				Sterile	Qty. Per Pack	Qty. Per Case
						L	W	H	B.N.D*			
CAF011025	25	12.5	2.5-3.75	8	Plug Seal	73.71	40.38	22.79	14.15	Y	10	200
CAF012025	25	12.5	2.5-3.75	8	Vent	73.71	40.38	22.79	14.15	Y	10	200
CAF011050	50	25.0	5-7.5	17.5	Plug Seal	92.88	49.5	29.08	18.2	Y	10	200
CAF012050	50	25.0	5-7.5	17.5	Vent	92.88	49.5	29.08	18.2	Y	10	200
CAF011250	250	75.0	15-22.5	60	Plug Seal	152.52	81.54	35.21	25	Y	5	100
CAF012250	250	75.0	15-22.5	60	Vent	152.52	81.54	35.21	25	Y	5	100
CAF011600	600	182.0	36.4-54.6	125	Plug Seal	219.28	115.74	38.3	29.5	Y	5	40
CAF012600	600	182.0	36.4-54.6	125	Vent	219.28	115.74	38.3	29.5	Y	5	40
CAF111600	600	182.0 (Extended)	36.4-54.6	200	Plug Seal	219.28	115.74	49.5	29.5	Y	5	40
CAF112600	600	182.0 (Extended)	36.4-54.6	200	Vent	219.28	115.74	49.5	29.5	Y	5	40
CAF011225	850	225.0	60-90	400	Plug Seal	221.9	137.2	49.5	25.65	Y	5	25
CAF012225	850	225.0	60-90	400	Vent	221.9	137.2	49.5	25.65	Y	5	25
CAF011850	850	300.0	60-90	200	Plug Seal	269.15	166	47	29.5	Y	3	18
CAF012850	850	300.0	60-90	200	Vent	269.15	166	47	29.5	Y	3	18

* Bottle Neck Diameter

CellATTACH® Cell and Tissue Culture Plates

Cat. No.	Well Qty.	Cell Growth Area (cm ²)	Qty. Per Box	Qty. Per Case
CAP011006	6	9.6	1	100
CAP011012	12	3.85	1	100
CAP011024	24	1.93	1	100
CAP011048	48	0.84	1	100
CAP011096	96	0.33	1	100
CAP012096	96U	0.58	1	100

CellATTACH® Cell and Tissue Culture Dishes

Cat. No.	Diameter (mm)	Cell Growth Area (cm ²)	Sterile	Qty. Per Box	Qty. Per Case
CAD010035	35	8.5	Y	10	240
CAD010060	60	21.2	Y	10	240
CAD010070	70	36.3	Y	10	240
CAD010090	90	55.0	Y	10	240
CAD010100	100	60.8	Y	10	240
CAD010150	150	143.0	Y	5	80

CellDETACH™ Temperature-Responsive Cell Culture Surface

Using trypsin digestion or cell scrapers to separate adherent cells can affect the expression of cell surface proteins, damage cells and reduce cell viability.

The CellDETACH™ products have a thermosensitive surface, which is coated with a unique nanopolymer. When the temperature decreases from 37°C to 4°C, the thermosensitive surface gradually changes from slightly hydrophobic to hydrophilic, allowing for the harvest of adherent cells without trypsin. By using this gentle collection method, the cells are safe from injuries caused by trypsin or scrapers, thus preserving high viability and the integrity of surface receptors and cell antigens. This operation enables cells to be harvested without damage for subculturing.

- Products: CellDETACH™ thermosensitive cell culture dishes 100 mm
CellDETACH™ thermosensitive cell culture flasks 600 mL

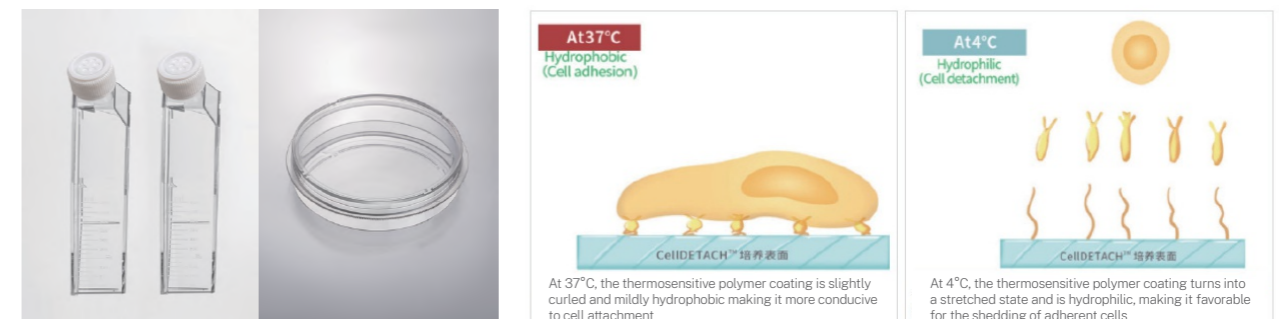

Features

The CellDETACH™ thermosensitive cell culture surface is specially designed by our R&D team for cell passage and cell transplantation, and has been granted a national invention patent (Patent Number: ZL201510780506.3). The goal is to help researchers harvest cell sheets, set up 3D tissue models formed by normal cell binding and extracellular matrix linkage, simplify cell culture and tissue engineering techniques, and minimize experimental manipulation time.

- National invention patent (patent number: ZL201510780506.3)
- Induces cell shedding simply by lowering the temperature -straightforward, fast, and easy to operate
- No trypsin: preserves cell surface proteins and marker integrity
- No cell scraping: avoids mechanical damage to cells and ensures high cell viability
- Optimized cell culture and tissue engineering techniques

Scope of Application

The thermosensitive cell culture surface is suitable for in vitro culture of most adherent cells, including stem cells, neural cells, macrophages, and cancer cells. It is ideal for harmless cell harvesting and can be widely used in expanded cell culture, cell therapy, 3D tissue modeling, extracellular matrix research and other fields.

Instructions for Use

In Vitro Cell Culture

1. When the temperature is above 32°C, the thermosensitive coating on the surface of the CellDETACH™ products is in a curled polymer state, showing slight hydrophobicity. This facilitates cell adherence and growth.
2. When the temperature goes below 32°C, the thermosensitive coating on the surface is in a stretched polymer state, which will bind water molecules and expand, showing hydrophilicity. This facilitates the shedding of adherent cells. The shedding efficiency will be at its best when the temperature drops below 4°C.
3. When the temperature of the thermosensitive cell culture surface drops below 32°C, excessive disturbance may cause cells to fall off, so please do not spend too much time taking pictures and observing while performing the cell culture.

Cell Harvest

1. The best harvest is achieved when the confluence of cells is higher than 80%.
2. When harvesting cells, either the environmental temperature should be reduced to 4°C, or the thermosensitive products should be placed in a sterile incubator at 4°C, or the culture can be replaced with a 4°C culture medium.
3. When the temperature of the thermosensitive Cell Culture Surface drops to 4°C, leave it for 20 to 30 minutes, then aspirate the culture medium above the thermosensitive Cell Culture Surface with a straw (cell culture dish), pipette or electric pipette (600 mL Cell Culture Flask), and blow over the cells attached to the culture surface to make them fall off. During the blowing process, the cell sheet can be observed falling off the thermosensitive surface.
4. The thermosensitive shedding abilities of cells depends on their adhesion performances, and some cells with strong adherence may have difficulty falling off, requiring multiple blowing attempts. (For example, those digested at 37°C for more than 3 minutes with 0.25% trypsin digestion are considered to be cells with strong adherence ability).

Storage and Transportation

5. This product should not be exposed to direct sunlight or excessive heat for a long time, but can be stored and transported at room temperature.

CellDETACH® Cell and Tissue Culture Dishes

Cat. No.	Diameter (mm)	Sterile	Appro.Cell Growth Area (cm ²)	Qty. Per Pack(Blister)	Qty. Per Case
CDD022100	100	Y	60.8	1	24
CDD023100	100	Y	60.8	5	100

CellDETACH® Cell and Tissue Culture Flasks

Cat. No.	Volume (mL)	Cell Culture Surface Area (cm ²)	Recommended Working Volume(mL)	Maximum Working Volume (mL)	Cap Style	Dimensions(mm)				Sterile	Qty. Per Bag	Qty. Per Case
						L	W	H	B.N.D.*			
CDF024600	600	182 (Extended)	36.4-54.6	200	Vent	219.28	115.74	49.5	29.5	Y	1	20
CDF023600	600	182 (Extended)	36.4-54.6	200	Vent	219.28	115.74	49.5	29.5	Y	5	40
CDF014600	600	182 (Extended)	36.4-54.6	200	Plug Seal	219.28	115.74	49.5	29.5	Y	1	20
CDF013600	600	182 (Extended)	36.4-54.6	200	Plug Seal	219.28	115.74	49.5	29.5	Y	5	40

* Bottle Neck Diameter

3D Sphearo™ Ultra-low Adsorption Surface

The 3DSphearo™ Ultra-low Adsorption Surface of JET BIOFIL is designed for spheroids (e.g. 3D tumor spheroid) and organoid cultures, providing a variety of product forms such as culture plates, culture dishes, and culture flasks. After the surface of the product is subjected to special gel treatment, the product has extremely strong anti-protein adsorption and anti-cell attachment, and there is almost no cell attachment on the surface, which is conducive to the suspension growth of cells and enables cell spheroid culture in a rapid, consistent, and reproducible manner.

- Specification: Ultra-low adsorption cell and tissue culture plates 6-well, 96-well (Flat bottom), 96-well (U-shaped bottom)
Ultra-low adsorption culture dishes (60 mm; 100 mm)
Ultra-low adsorption culture flask T75
- Material: Polystyrene (PS), Flask cap: High-density polyethylene (HDPE), conforming to USP Class VI standards

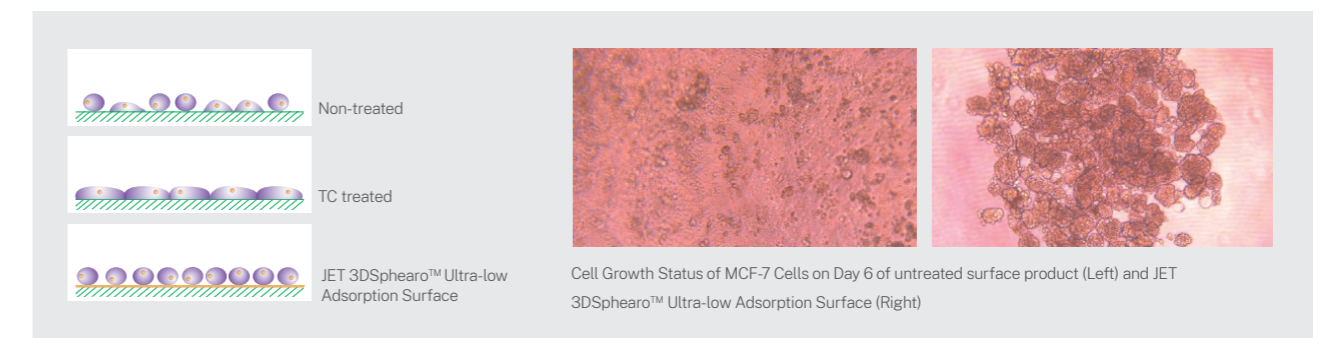

Features

- The Ultra-low Adsorption Surface has a covalently bonded hydrogel layer with extremely strong anti-protein adsorption and anti-cell attachment, which can effectively inhibit cell attachment and minimize protein adsorption, enzyme activation, and cell activation
- The surface is non-cytotoxic, biologically inert and non-degradable
- The coating on the surface is firm and convenient for daily experimental operation
- It has been verified by different cell culture tests that there is almost no cell attachment on the surface and enables cell spheroid culture in a rapid, reproducible, consistent, and reliable manner
- Provide a variety of Ultra-low Adsorption Surface to meet different experimental needs of customers
- Each package bag is printed with lot No. for quality traceability
- Sterilized by irradiation, SAL 10⁻⁶
- DNase/RNase-free, non-pyrogenic, and non-cytotoxic

Cat. No.	Product Name	Specification	Surface Type	Sterile	Qty. Per Bag	Qty. Per Case
TCP030006	Culture plate	6-well	Ultra-low adsorption	Y	1	60
TCP030096	Culture plate	96-well (Flat bottom)	Ultra-low adsorption	Y	1	60
TCP130096	Culture plate	96-well (U-shaped bottom)	Ultra-low adsorption	Y	1	60
TCD030060	Culture dish	60 mm	Ultra-low adsorption	Y	5	80
TCD030100	Culture dish	100 mm	Ultra-low adsorption	Y	5	80
TCF030250	Culture flask	T75 (250 mL, vent)	Ultra-low adsorption	Y	1	60

Tissue Culture Plate Inserts

Tissue culture plate inserts are extensively used in a variety of cell tests, including co-culture tests, chemotaxis tests, and cell migration tests. With the membrane technology, cells that grow in vitro are more similar to those growing in vivo in terms of morphology and function. They are also used for studying cell functions such as cellular transport, absorption and secretion.

- Membrane Pore Size: 0.1 μm 0.4 μm 3.0 μm 5.0 μm 8.0 μm 12.0 μm
- Specification: 6-well 12-well 24-well
- Materials: Membrane: Polycarbonate(PC)/Polyethylene terephthalate(PET),
Main Body: Polystyrene (PS), conforming to USP Class VI standards



Features

- Excellent transmittance of the PET membrane, facilitating observation by microscope; Compared to the PET membrane, cell adhesion is stronger on the PC membrane and its higher pore density enables easier exchange of transmembrane substances
- 3 configurations of cell culture plate inserts and a variety of membrane pore sizes are available to meet a variety of different experimental requirements
- Innovative nested edge design facilitates sample addition
- Special central suspension design protects monolayer cells while preventing cell culture medium loss
- Excellent chemical compatibility of the membrane makes it compatible with most staining and fixed reagents
- Sterilized by irradiation, SAL 10^{-6}
- DNase/RNase-free, non-pyrogenic and non-cytotoxic

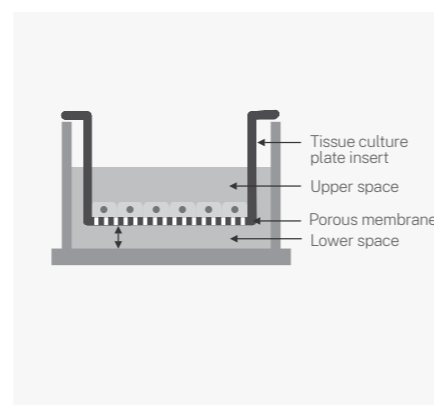

Chemical Compatibility

The PC membrane and PET membrane are suitable for histological fixatives such as methanol and formaldehyde, and also tolerate alcohol, amines, lipids, ethers, ketones and petroleum solvents (such as halogenated hydrocarbon and DMSO). In particular, the PET membrane has very good chemical applicability. However, strong acidic and alkaline solutions are not recommended.

Pore Density

The PET membrane and PC membrane have a rated pore density. In comparison, the PET membrane has a lower pore density than the PC membrane but is superior in terms of its optical performance.

The central suspension design of our tissue culture plate inserts leaves a certain distance between the nest and the bottom, so that the monolayer cells will not be destroyed when the nest is moved away, and culture medium loss via capillary action between the nested wall and pore wall can be prevented.

Polycarbonate (PC) Membrane Tissue Culture Plate Inserts

Cat. No.	Well	Pore Size (μm)	Growth Area for Insert Membrane (cm^2)	Sterile	Qty. Per Box	Qty. Per Case
TCS000006	6	0.1	4.67	Y	6	24
TCS001006	6	0.4	4.67	Y	6	24
TCS005006	6	1.0	4.67	Y	6	24
TCS002006	6	3.0	4.67	Y	6	24
TCS003006	6	8.0	4.67	Y	6	24
TCS100006	6	12.0	4.67	Y	6	24
TCS000012	12	0.1	1.12	Y	12	48
TCS001012	12	0.4	1.12	Y	12	48
TCS005012	12	1.0	1.12	Y	12	48
TCS002012	12	3.0	1.12	Y	12	48
TCS003012	12	8.0	1.12	Y	12	48
TCS100012	12	12.0	1.12	Y	12	48
TCS000024	24	0.1	0.33	Y	12	48
TCS001024	24	0.4	0.33	Y	12	48
TCS005024	24	1.0	0.33	Y	12	48
TCS002024	24	3.0	0.33	Y	12	48
TCS003024	24	8.0	0.33	Y	12	48
TCS004024	24	5.0	0.33	Y	12	48
TCS100024	24	12.0	0.33	Y	12	48

Polyethylene Terephthalate (PET) Membrane Tissue Culture Plate Inserts

Cat. No.	Well	Pore Size (μm)	Growth Area for Insert Membrane (cm^2)	Sterile	Qty. Per Box	Qty. Per Case
TCS017006	6	0.1	4.67	Y	6	24
TCS016006	6	0.4	4.67	Y	6	24
TCS018006	6	1.0	4.67	Y	6	24
TCS019006	6	3.0	4.67	Y	6	24
TCS020006	6	8.0	4.67	Y	6	24
TCS017012	12	0.1	1.12	Y	12	48
TCS016012	12	0.4	1.12	Y	12	48
TCS018012	12	1.0	1.12	Y	12	48
TCS019012	12	3.0	1.12	Y	12	48
TCS020012	12	8.0	1.12	Y	12	48
TCS017024	24	0.1	0.33	Y	12	48
TCS016024	24	0.4	0.33	Y	12	48
TCS018024	24	1.0	0.33	Y	12	48
TCS019024	24	3.0	0.33	Y	12	48
TCS020024	24	8.0	0.33	Y	12	48

Polycarbonate (PC) Membrane Tissue Culture Plate Inserts

Cat. No.	Pore Size (µm)	Culture Area (cm ²)	Suggested Working Volume (mL)	Qty. Per Plate	Qty. Per Case
TCS021024	0.4	0.47	1.1	24	96

100 mm Tissue Culture Dish Insert

Tissue Culture Dish Inserts are extensively used in a variety of cell experiments. The membrane technology is used to simulate the original growth environment of cells and make cells growing in vitro closer to cells growing in vivo in terms of morphology and function. The 100 mm Tissue Culture Dish Inserts from JET BIOFIL are made of translucent polycarbonate membranes (PC), providing superior cell adhesion, high pore density, and enhanced capacity for transmembrane substance exchange. The inserts are ideal for various tests such as co-culturing and cellular molecular transport, as well as research into cell functions like transport, absorption and secretion.

- Insert Diameter: 75 mm
- Culture dish Diameter: 100 mm
- Culture area of etched membrane: 44 cm²
- Membrane pore size: 0.4 µm, 3.0 µm
- Material: Membrane: Polycarbonate (PC); The main body: Polystyrene (PS); Conforming to USP Class VI standards



Features

- The inserts paired with translucent PC membrane feature high pore density and are ideal for cell migration and invasion.
- PC membrane boasts strong chemical compatibility, making it compatible with most organic solvents and stains.
- Surface treated with TC, suitable for adhesion of various cell types.
- The suspended design positions the etched membrane approximately 1.5 mm from the insert bottom, preserving monolayer cells due to insert movement and preventing the loss of media due to capillary action.
- The inserts have three side openings design that facilitates easy access for tests and allows for gas exchange in the culture environment. These openings also allow standard pipettes be able to added or removed samples from the bottom compartment.
- Sterilized by irradiation, SAL 10⁻⁶
- DNase/RNase-free, non-pyrogenic and non-cytotoxic

Cat. No.	Membrane Diameter (mm)	Culture Area (cm ²)	Membrane Pore Size (µm)	Membrane Material	Optical Properties	Recommended Working Volume (mL)		Sterile	Qty. Per Bag	Qty. Per Case
						Culture Dish	Insert			
TCS001100	75	44	0.4	PC	Translucent	13	9	Y	1	24
TCS002100	75	44	3.0	PC	Translucent	13	9	Y	1	24

Confocal Dishes

Confocal dishes, which are as convenient as 35 mm culture dishes and as advantageous as coverslips in terms of imaging, can provide the advanced optical performance required by high-magnification microscopes and confocal image analysis. They are used extensively in fluorescence microscopy, phase contrast microscopy, confocal microscopy, live cell imaging, differential interference contrast microscope, and fluorescence in situ hybridization (FISH).

- Apertures Specification: 15 mm 20 mm
- Materials: PS and borosilicate glass (bottom), conforming to USP Class VI standards
- Surface: TC-treated

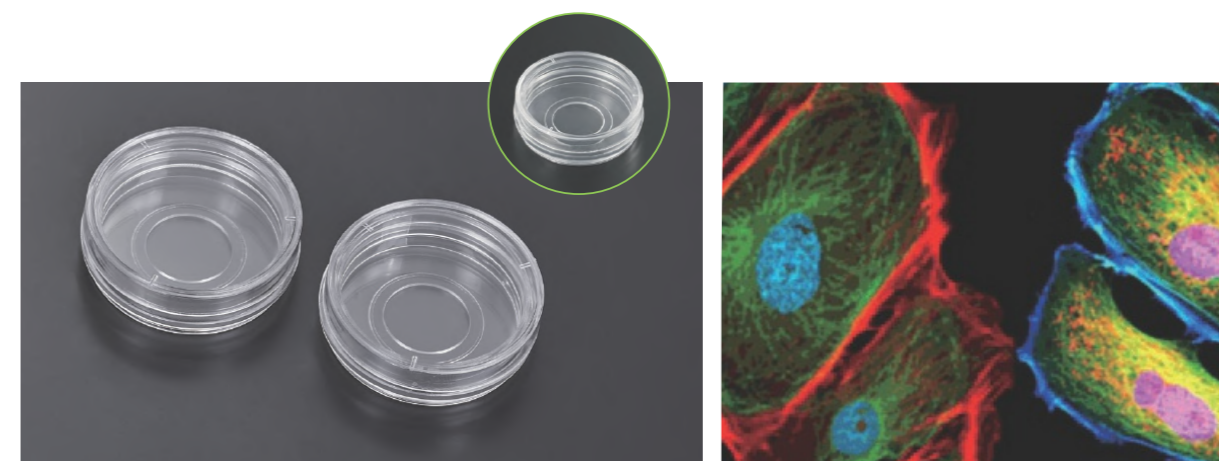

Features

- 2 apertures available: 15 mm and 20 mm; glass thickness: 0.16-0.19 mm
- The glass bottom is free of autofluorescence and deformation. Made of borosilicate, it is extremely hydrophilic and has good light permeability
- Suitable for fluorescence microscopy, laser scanning confocal microscopy, and phase contrast microscopy.
- Spliced with medical-grade traceless glue, bringing excellent transparency and facilitating cell observation
- Sterilized by irradiation, SAL 10⁻⁶
- DNase/RNase-free, non-pyrogenic and non-cytotoxic

Confocal Dishes

Cat. No.	Aperture (mm)	Surface Type	Sterile	Qty. Per Bag	Qty. Per Case
BDD011035	15	TC-treated	Y	10	240
BDD012035	20		Y	10	240

CellSLIP® Coverslips

CellSLIP® Coverslips are a kind of laboratory consumables used for enabling adherent cells growth on certain solid surfaces (such as coverslips and glass slides) based on various experimental requirements. For scientific research involving a large number of test samples and multiple testing indicators, numerous cells are required for HE staining and immunohistochemical staining. However, many coverslips available on the market have some weaknesses. For instance, some coverslips are made of glass, which is fragile; other coverslips are designed without handles and are difficult to pick up. Cells may grow on the coverslips during the course of a culture. The culture dish with coverslips produced by JET BIOFIL (patent number: ZL201520113833.9, ZL201420594580.7, ZL201420594259, and ZL200610047607.0) solves the weaknesses of common coverslips and greatly facilitate experimental research and application.

- ◎ Specification of Culture Dish: 60 mm 100 mm
- ◎ Specification (diameter) of Coverslip: 8 mm 10 mm
- ◎ Number of Coverslips: 12 pcs 18 pcs 32 pcs 45 pcs

- ◎ Materials: Culture Dish: Polystyrene (PS), Coverslip: Polyethylene terephthalate (PET), conforming to USP Class VI standards

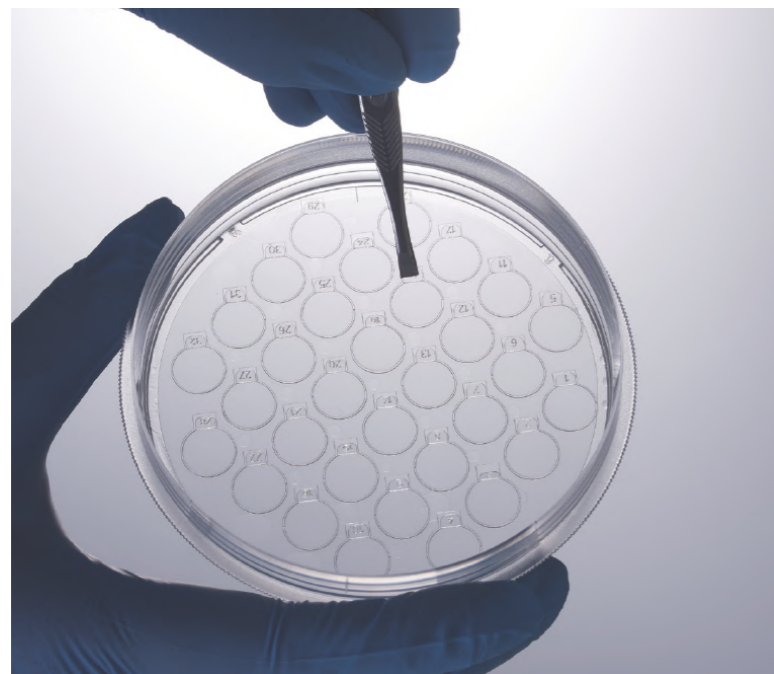

The handle of coverslip is tilted at a certain angle so that operators could hold them easily.



Rounded coverslips for different kinds of experiments and detections can be prepared in a single cell culture, greatly improving overall efficiency.

Features

- ◎ The coverslip is made of PET, that is strong and not fragile
- ◎ Excellent transparency and transmittance, making it possible to observe cells clearly under light microscopes and fluorescence microscopes
- ◎ Coverslips can be prepared for different kinds of tests in one experiment, greatly improving efficiency
- ◎ The handle of the coverslip is cocked at an angle so that operators can hold them easily; the handle is printed with a number for easy identification
- ◎ Sterilized by irradiation, SAL 10⁶
- ◎ DNase/RNase-free, non-pyrogenic and non-cytotoxic

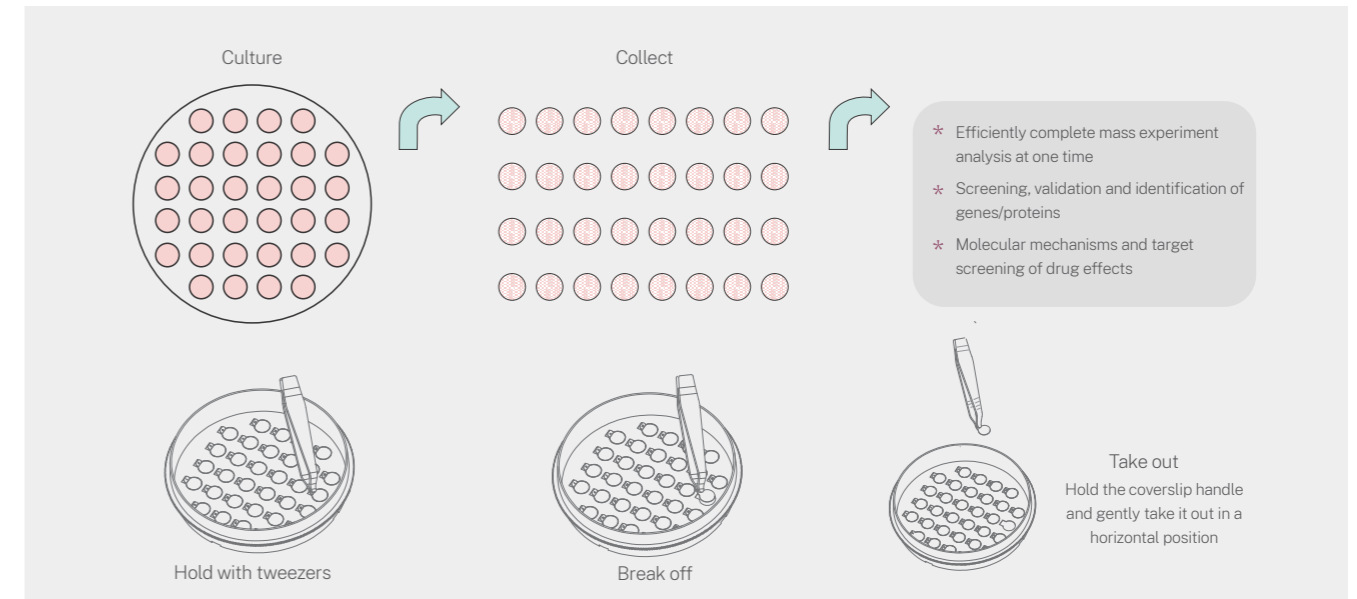

Coverslips

Cat. No.	Dish	Coverslip Qty.	Diameter (mm)	Appro.Cell Growth Area (cm ²)-Single	Appro.Cell Growth Area (cm ²)-Total	Plate	Qty. Per Box	Qty. Per Case
CXD206008	60 mm	18	8	0.50	9.00	48	1	48
CXD206010	60 mm	12	10	0.79	9.42	48	1	48
CXD310008	100 mm	45	8	0.50	22.50	48	1	48
CXD310010	100 mm	32	10	0.79	25.12	48	1	48

CellSCAFLD® 3D Cell Culture Scaffolds

The conventional cell culture is performed using 2D planes, and the growth model of 2D cell cultures is very different from the 3D environment in vivo. This causes significant differences in cellular morphology, cell differentiation, cell-matrix interaction and intercellular interaction when compared to the behavior under physiological conditions in vivo. A 3D cell culture provides an ideal simulated environment for an in vivo pattern of cell growth.

The 3D cell culture scaffold produced by JET BIOFIL (patent number: ZL201620728244.6, ZL201620728243.1 and 201510783345.3) is an ideal tool for studying 3D cell cultures, the mechanism of interaction between cells, cellular immunotherapy and stem cell therapy, drug screening, as well as drug production. Furthermore, it improves the cell culture area and increases the yield significantly.

This 3D cell culture scaffold can be used with 6, 12, 24 well culture plates and culture dishes of different sizes such as 3.5 cm, 6.0 cm, and 7.0 cm.

- ◎ Materials: Polystyrene (PS), conforming to USP Class VI standards

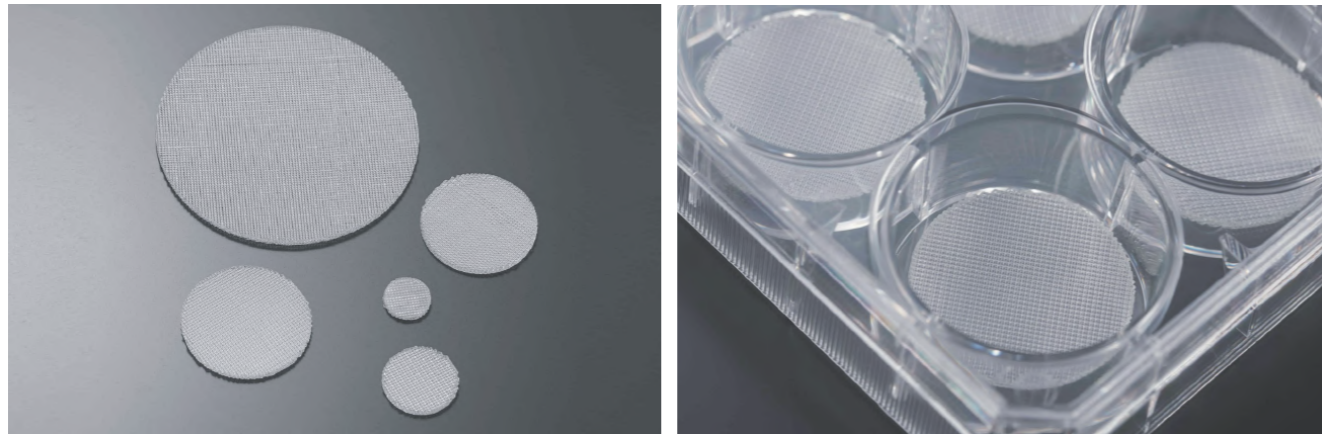

Features

- Average wire diameter: 500µm; average spacing of wire column: 260 µm, with high regularity. The product consists of a 3D porous structure with good connectivity, facilitating the transmission of different nutritional ingredients in the course of the 3D cell culture, and ensuring the consistency of metabolic activity and accuracy of culture results
- In comparison to the 2D cell culture, the 3D cell culture allows for easier cell function expression since it simulates the 3D structure of human and animal cells to a maximum level and provides an ideal interactive environment between cells
- The 3D cell culture scaffold has a much larger culture surface area than conventional 2D cell culture products, thus saving on both space and material, and significantly improving cell culture efficiency and yield.
- Cells adhere strongly to the surface because of the advanced hydrophilic treatment
- No adsorption of cytokines or growth factors; cell and cell secretions can be directly isolated from the 3D scaffold when harvesting
- Sterilized by irradiation, SAL 10⁻⁶
- DNase/RNase-free, non-pyrogenic and non-cytotoxic

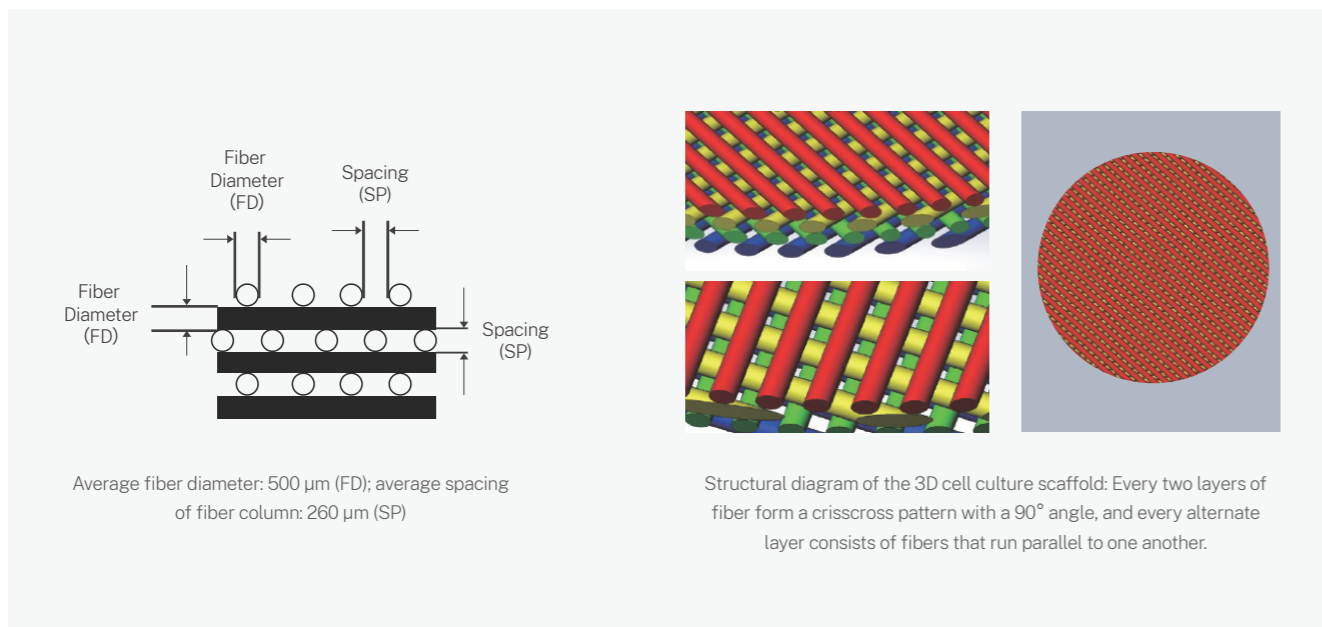

Cat. No.	Type	JET CellSCAFLD® 3D Cell Culture			Number of Brackets/ Box	Bracket Surface Area (cm ²)	Total Surface Area of the Stent (cm ²)	Characteristic	Qty. Per Box	Qty. Per Case
		Size (mm)	Fiber Diameter (µm)	Aperture (µm)						
TDD032035	3.5 cm	32.0x1.6	500	260	1	43	43	The 3D scaffold has a four-layered three-dimensional structure with a highly hydrophilic surface for adherent culture.	1	40
TDD032060	6.0 cm	51.0x1.6	500	260	1	109	109		1	30
TDD032070	7.0 cm	67.5x1.6	500	260	1	191	191		1	30
TDP032006	6 Well	33.5x1.6	500	260	3	48	144		1	8
TDP032012	12 Well	21.0x1.6	500	260	6	19	114	The 3D scaffold is built into the culture plate well or culture dish.	1	8
TDP032024	24 Well	15.0x1.6	500	260	12	10	120		1	8

Bio-Reaction Tubes

Bio-reaction tubes are suitable for use in the high-throughput condition optimization process for suspension cell culture, including research and clonal selection of cell lines, culture medium optimization and recombinant protein development.

- Specification: 15 mL 50 mL
- Bottom Type: Conical Self-standing
- Packaging: Re-sealable Bag Paper Rack
- Materials: Tube Body: Polypropylene (PP), Tube Cap: High-density Polyethylene (HDPE), conforming to USP Class VI standards



Features

- Inner/outer surfaces of the tube are smooth with an even luster
- The white silk screen can be used for recording experimental data
- Hydrophobic vent cap for continuous gas exchange
- Maximum RCF: 12,000×g
- Sterilized by irradiation, SAL 10⁻⁶
- DNase/RNase-free, non-pyrogenic and non-cytotoxic

Cat. No.	Volume (mL)	Bottom	Max RCF (xg)	Sterile	Package	Qty. Per Bag(Rack)	Qty. Per Case
BRT000015	15	Conical	12,000	Y	Re-sealable bag	10	100
BRT010015	15	Conical	12,000	Y	Paper rack	50	300
BRT000050	50	Conical	12,000	Y	Re-sealable bag	10	100
BRT010050	50	Conical	12,000	Y	Paper rack	25	300
BRT011050	50	Self-standing	6,000	Y	Re-sealable bag	10	100

Cat. No.	Volume (mL)	Speciality	Sterile	Qty. Per Bag	Qty. Per Case
BRC000050	50	Tube Cap	Y	25	1000

Culture Tubes

Culture tubes are primarily used to culture tissues and bacteria, to store clinical samples, including powder or liquid samples, and to conduct molecular biology tests, such as ELISA tests, RIA analysis and flow cytometry.

- ◎ Specification: 4 mL 5 mL 8 mL 14 mL
- ◎ Bottom Type: Round Conical
- ◎ Cap Type: Dual-position sealed type Plug-type
- ◎ Materials: Tube Body: Polypropylene (PP)/Polystyrene (PS), Tube Cap: Polyethylene (PE), conforming to USP Class VI standards



Features

- ◎ Four capacities: 4 mL, 5 mL, 8 mL and 14 mL
- ◎ Round and conical bottoms available
- ◎ Smooth inner and outer tube surfaces: PS for higher transparency, and PP for better chemical compatibility
- ◎ Dual-position sealed and plug caps are available: flexible operation with no sample loss.
- ◎ The 12×75 mm-long(5 mL) polystyrene round bottom tube is widely used in flow cytometry.
- ◎ Sterilized and non-sterilized available, sterilized by irradiation to SAL 10⁻⁶
- ◎ DNase/RNase-free, non-pyrogenic and non-cytotoxic

Cat. No.	Volume (mL)	Cap Style	Bottom	Material	Sterile	Qty. Per Bag	Qty. Per Case
TUB000004	4	Without cap	Conical	PP	N	1	1000
TUB010004	4	Without cap	Conical	PS	N	1	1000
TUB020004	4	Dual cap	Conical	PP	Y	25	500
TUB012004	4	Dual cap	Conical	PS	Y	25	500
TUB000005	5	Without cap	Round	PP	N	1	1000
TUB011005	5	Without cap	Round	PS	N	1	1000

Cat. No.	Volume (mL)	Cap Style	Bottom	Material	Sterile	Qty. Per Bag	Qty. Per Case
TUB022005	5	Plug cap	U-Bottom	PP	Y	25	500
TUB023005	5	Plug cap	U-Bottom	PS	Y	25	500
TUB025005	5	Dual cap	U-Bottom	PP	Y	25	500
TUB028005	5	Dual cap	U-Bottom	PS	Y	25	500
TUB000008	8	Without cap	U-Bottom	PP	N	1	1000
TUB011008	8	Without cap	U-Bottom	PS	N	1	1000
TUB002008	8	Without cap	U-Bottom	PP	Y	125	1000
TUB013008	8	Without cap	U-Bottom	PS	Y	125	1000
TUB002140	14	Without cap	U-Bottom	PP	N	1	1000
TUB004140	14	Without cap	U-Bottom	PS	N	1	1000
TUB100140	14	Dual cap	U-Bottom	PS	N	50	500
TUB111140	14	Dual cap	U-Bottom	PS	Y	25	500
TUB000140	14	Dual cap	U-Bottom	PP	N	50	500
TUB011140	14	Dual cap	U-Bottom	PP	Y	25	500

15 mL PS Centrifuge Tubes

15 mL PS centrifuge tubes are made of USP Class VI standards polystyrene (PS) for better transparency.

- ◎ Specification: 15 mL
- ◎ Bottom Type: Conical Bottom
- ◎ Packaging: Re-sealable Bag Paper Rack Plastic Rack
- ◎ Materials: Tube Body: Polystyrene (PS), Tube Cap: High-density polyethylene (HDPE), conforming to USP Class VI standards

Features

- ◎ The scale is clear and easy to read
- ◎ High transparency, suitable for biological experiments
- ◎ Tube cap comes with a leak-proof gasket
- ◎ Maximum RCF: 3,000×g
- ◎ Sterilized by irradiation, SAL 10⁻⁶
- ◎ DNase/RNase-free, non-pyrogenic and non-cytotoxic



Cat. No.	Volume (mL)	Material	Sterile	Package	Qty. Per Bag(Rack)	Qty. Per Case
CFT410150	15	PS	N	Re-sealable bag	50	500
CFT411150	15	PS	Y	Re-sealable bag	25	500
CFT421150	15	PS	Y	Paper rack	25	500
CFT721150	15	PS	Y	Plastic rack	25	300
CFT412150	15	PS	Y	Re-sealable bag	25	500
CFT422150	15	PS	Y	Paper rack	25	500
CFT722150	15	PS	Y	Plastic rack	25	300

Cell Strainers

Cell strainers are suitable for the preparation of samples for flow cytometric analysis and single cell suspension of blood cells, the rapid separation of primary cultured cells and primary cells from tissues, etc., They are also suitable for prefiltration of solutions containing particles with a diameter greater than 40 μm , and cleaning of cell suspension before cell subculture, counting, analysis or cryopreservation.

- ◎ Pore Size: 40 μm 70 μm 100 μm
- ◎ Color: Blue White Yellow
- ◎ Materials: Frame: Polypropylene (PP), Bottom: Nylon mesh, conforming to USP Class VI standards

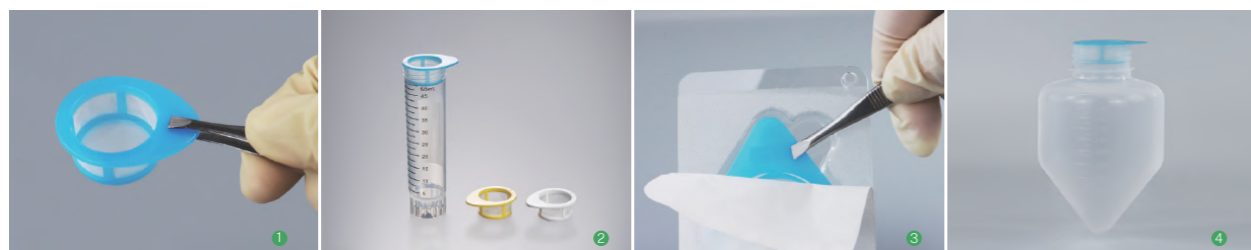

Features

- ◎ The bottom is made of an evenly distributed nylon mesh, providing reliable experimental results with consistency
- ◎ 40, 70 and 100 μm pore sizes available with different colors for simple recognition
- ◎ The top extended edge can be operated aseptically with forceps
- ◎ Groove on the package for convenient access
- ◎ Molded polypropylene frame can be marked in different colors for easy handling and identification
- ◎ Suitable for JET BIOFIL's 50 mL centrifuge tubes and 500 mL large-capacity conical centrifuge bottles
- ◎ Sterilized and non-sterilized available, sterilized by irradiation to SAL 10^{-6}
- ◎ DNase/RNase-free, non-pyrogenic and non-cytotoxic

Cat. No.	Pore Size (μm)	Strainer Diameter (mm)	Color	Sterile	Qty. Per Box	Qty. Per Case
CSS013040	40	20.5	Blue	Y	50	200
CSS013070	70	20.5	White	Y	50	200
CSS013100	100	20.5	Yellow	Y	50	200

Extra large model (paper plastic bag), suitable for JET BIOFIL 500 mL large-capacity conical centrifuge bottles

Cat. No.	Pore Size (μm)	Strainer Diameter (mm)	Color	Sterile	Qty. Per Box	Qty. Per Case
CSS015040	40	30.7	Blue	Y	50	200
CSS015070	70	30.7	White	Y	50	200
CSS015100	100	30.7	Yellow	Y	50	200

Extra large model (blister packed), suitable for JET BIOFIL 500 mL large-capacity conical centrifuge bottles

Cat. No.	Pore Size (μm)	Strainer Diameter (mm)	Color	Sterile	Qty. Per Box	Qty. Per Case
CSS025040	40	30.7	Blue	Y	50	200
CSS025070	70	30.7	White	Y	50	200
CSS025100	100	30.7	Yellow	Y	50	200

Pestles for Cell Strainer

The cell strainer pestle consists of a handheld columnar pestle, a flat columnar grinding head, and a component for connecting the pestle to the grinding head. The convex design increases the contact area of the grinding head with the ground materials. It also increases frictional force during the grinding process so as to optimize the grinding effect.

- ◎ Materials: Polypropylene (PP), conforming to USP Class VI standards

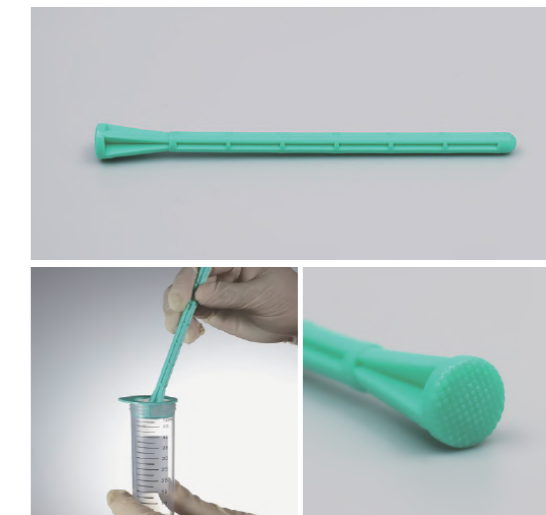

Features

- ◎ Hard and wear-resistant PP
- ◎ Mesh lines at the bottom for optimized grinding effect
- ◎ Specially designed handle, slip-resistant and easy to hold
- ◎ Reduces sample loss when combined with the cell strainer
- ◎ Sterilized by irradiation, SAL 10^{-6}
- ◎ DNase/RNase-free, non-pyrogenic and non-cytotoxic

Cat. No.	Description	Sterile	Qty. Per Tray	Qty. Per Case
CSP001001	Pestle for Cell Strainer, Green, Individually Packaged	Y	1	100

Pestles for 1.5 mL Micro Centrifuge Tube

The disposable pestles are made of high-quality PP. They can be used in combination with 1.5 mL micro centrifuge tubes to finely grind soft tissue samples and to resuspend proteins, DNA, etc.

- Materials: Polypropylene (PP), conforming to USP Class VI standards



Features

- Made of high-quality PP, hard and wear resistant
- Specially designed handle is slip-proof and easy to hold
- Can be used in combination with 1.5 mL micro centrifuge tubes, facilitating fine sample grinding
- Sterilized by irradiation, SAL 10⁻⁶
- Single independent package for easy operation
- DNase/RNase-free, non-pyrogenic and non-cytotoxic

Cat. No.	Length (mm)	Description	Sterile	Qty. Per Bag	Qty. Per Case
CSP001002	78	White, Individually packaged	Y	1	100
CSP002002	78	White, Bulk package	Y	100	1000
CSP003002	78	White, Pestle and Microtube Combo	Y	1	100

Cell Scrapers

Cell Scrapers: The specially designed cell scraper features a turning function to ensure that an ideal angle is maintained during cell collection, which makes it convenient for manually harvesting adherent cells from culture vessels.

Rotatable Cell Scrapers: The blade angle of the cell scraper changes with a slight pressure on the handle using the forefinger, which pushes the handle downward towards the floor of the culture vessel.

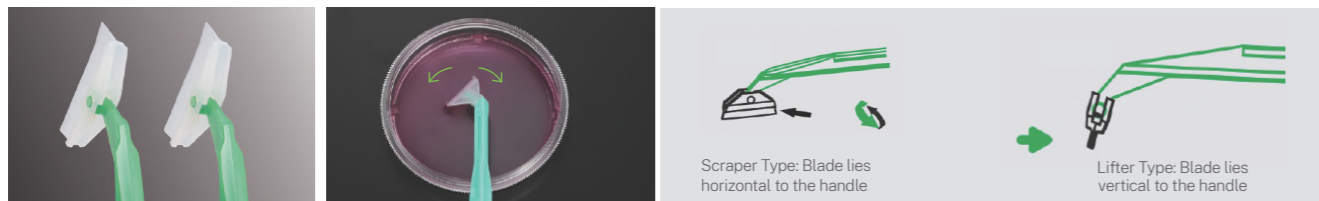

Scraper Type: Blade lies horizontal to the handle

Lifter Type: Blade lies vertical to the handle

Cell Scrapers:

- Length: 25 cm 39 cm
- Blade Specification: 2.0 cm 3.0 cm
- Materials: Blade: TPE, Handle: ABS, conforming to USP Class VI standards

Features

- Two blade specifications available: scraper and lifter
- Specially designed to make the process of scraping and collecting cells easier and more effective
- Ultra-thin, flexible swivel blades are easy to use, reducing cell damage
- Easy removal and collection of cells using a scraping or lifting motion
- The 25 cm cell scraper is suitable for T25 and T75 culture flasks, while the 39 cm cell scraper is designed for other culture flasks/spinner bottles with higher capacities
- Individually wrapped
- Sterilized by irradiation, SAL 10⁻⁶
- DNase/RNase-free, non-pyrogenic and non-cytotoxic

Cat. No.	Blade (cm)	Total Length (cm)	Material	Blade Position	Sterile	Qty. Per Bag	Qty. Per Case
CSC011025	2.0	25	Blade/TPE; Handle/ABS	Scraper	Y	1	100
CSC012025	2.0	25	Blade/TPE; Handle/ABS	Lifter	Y	1	100
CSC011039	3.0	39	Blade/TPE; Handle/ABS	Scraper	Y	1	100
CSC012039	3.0	39	Blade/TPE; Handle/ABS	Lifter	Y	1	100

Rotatable Cell Scrapers:

- Length: 23 cm 30 cm
- Blade Specification: 12 mm 20 mm
- Materials: Blade: PE, Handle: ABS, conforming to USP Class VI standards

Features

- Available in 2 different lengths: 23 cm and 30 cm
- Rotating blade rotates in any required direction
- Full access to every corner
- Ribbed handle
- Individually wrapped
- Sterilized by irradiation, SAL 10⁻⁶
- DNase/RNase-free, non-pyrogenic and non-cytotoxic

Cat. No.	Blade (mm)	Total Length (cm)	Material	Sterile	Qty. Per Bag	Qty. Per Case
CSC211023	12	23	Blades/PE; Handle/ABS	Y	1	150
CSC211030	20	30	Blades/PE; Handle/ABS	Y	1	150
CSC212023	20	23	Blades/PE; Handle/ABS	Y	1	150
CSC212030	12	30	Blades/PE; Handle/ABS	Y	1	150

Exchangeable Cell Blade and Lifters

The cell blades, which are made of high quality polyethylene (PE), feature excellent toughness to protect cells during cell collection marking them best tool for cell collection in a laboratory.

- Style: 9.0 mm J-Hook 2.5 mm Narrow Blade
- Color: White Light green
- Materials: Polyethylene (PE), conforming to USP Class VI standards



Features

- Available in two different styles: 9.0 mm J-Hook and 2.5 mm Narrow Blade.
- Easy to operate, with a special blade design to minimize cell damage
- Spacious shovel blade design for easy and fast operation
- Unique dual-function design with a "scraper-type" structure at the other end to provide access to every hard-to-reach corner
- Sterilized by irradiation, SAL 10⁻⁶
- DNase/RNase-free, non-pyrogenic and non-cytotoxic

Cat. No.	Description	Sterile	Qty. Per Bag	Qty. Per Case
CSC013001	9.0 mm J-Hook, Green Color	Y	1	100
CSC013002	2.5 mm Narrow Blade, Green Color	Y	1	100

L-shaped Cell Spreaders

L-shaped cell spreaders are ideal tools for achieving even cell or bacterial growth in a culture dish or culture plate.

- Materials: Polypropylene (PP), conforming to USP Class VI standards



Features

- Smooth surface to minimize scratches
- Upward tail design significantly reduces the risk of culture medium damage
- No need for high-temperature flame sterilization
- Sterilized by irradiation, SAL 10⁻⁶
- DNase/RNase-free, non-pyrogenic and non-cytotoxic

Cat. No.	Description	Qty. Per Bag	Qty. Per Case
CSP011014	PP, Individually Wrapped, Sterile	1	100
CSC012014	PP,10 Per pack, Sterile	10	500

Cryogenic Vials

The cryogenic vials are made of transparent polypropylene (PP). By means of a special process, they have been manufactured to withstand ultra-low temperatures. Fully sealed to avoid leakage, the cryogenic vials are suitable for long-term cryopreservation of cells and tissues.

- Specification: 0.5 mL 1.5 mL 1.8 mL 2.0 mL 5.0 mL
- Cap Type: Flat Socket
- Bottom Type: Conical Self-standing
- Materials: Tube Body: Polypropylene (PP), Tube Cap: High-density polyethylene (HDPE), conforming to USP Class VI standards



Features

- 5 specifications available: 0.5 mL, 1.5 mL, 1.8 mL, 2.0 mL, 5.0 mL
- The tube is made of PP, that is smooth and transparent. It can resist ultra-low temperatures and withstand repeated freezing and thawing
- Tube body designed with both graduation and writing area for easy identification, observation and labeling
- Silica gel sealing washer inside the sealing cap eliminates liquid leakage
- Working temperature range: -196°C (LN₂ gas phase) -121°C
- Max. liquid storage volume for freezing: 80% of max. graduation
- Sterilized by irradiation, SAL 10⁻⁶
- DNase/RNase-free, non-pyrogenic and non-cytotoxic

0.5mL Cryogenic Vials with Flat Cap

Cat. No.	Capacity (mL)	Vial Color	Bottom	Lid Color	Graduation Line	Sterile	Package	Qty.Per Bag	Qty.Per Case
FCT511005	0.5	Natural	Self-Standing	Natural	N	N	Bag	50	5000
FCT511105	0.5	Natural	Self-Standing	Red	N	N	Bag	50	5000
FCT511205	0.5	Natural	Self-Standing	Orange	N	N	Bag	50	5000
FCT511305	0.5	Natural	Self-Standing	Blue	N	N	Bag	50	5000
FCT511405	0.5	Natural	Self-Standing	Yellow	N	N	Bag	50	5000
FCT511505	0.5	Natural	Self-Standing	Green	N	N	Bag	50	5000
FCT511605	0.5	Natural	Self-Standing	Pink	N	N	Bag	50	5000
FCT511705	0.5	Natural	Self-Standing	Brown	N	N	Bag	50	5000
FCT511805	0.5	Natural	Self-Standing	White	N	N	Bag	50	5000
FCT511905	0.5	Natural	Self-Standing	Black	N	N	Bag	50	5000
FCT512005	0.5	Natural	Self-Standing	Natural	N	Y	Bag	50	5000
FCT512105	0.5	Natural	Self-Standing	Red	N	Y	Bag	50	5000
FCT512205	0.5	Natural	Self-Standing	Orange	N	Y	Bag	50	5000
FCT512305	0.5	Natural	Self-Standing	Blue	N	Y	Bag	50	5000
FCT512405	0.5	Natural	Self-Standing	Yellow	N	Y	Bag	50	5000
FCT512505	0.5	Natural	Self-Standing	Green	N	Y	Bag	50	5000
FCT512605	0.5	Natural	Self-Standing	Pink	N	Y	Bag	50	5000
FCT512705	0.5	Natural	Self-Standing	Brown	N	Y	Bag	50	5000
FCT512805	0.5	Natural	Self-Standing	White	N	Y	Bag	50	5000
FCT512905	0.5	Natural	Self-Standing	Black	N	Y	Bag	50	5000
FCT512005-1	0.5	Natural	Self-Standing	Natural	N	Y	Vial and Lid Separated	1000	5000
FCT512105-1	0.5	Natural	Self-Standing	Red	N	Y	Vial and Lid Separated	1000	5000
FCT512305-1	0.5	Natural	Self-Standing	Blue	N	Y	Vial and Lid Separated	1000	5000
FCT512505-1	0.5	Natural	Self-Standing	Green	N	Y	Vial and Lid Separated	1000	5000
FCT514005	0.5	Natural	Self-Standing	Green	N	Y	Vial and Lid Separated	500	5000
FCT515005	0.5	Natural	Self-Standing	Red	N	Y	Vial and Lid Separated	500	5000
FCT516005	0.5	Natural	Self-Standing	Natural	N	Y	Vial and Lid Separated	250	5000
FCT516105	0.5	Natural	Self-Standing	Red	N	Y	Vial and Lid Separated	250	5000
FCT516305	0.5	Natural	Self-Standing	Blue	N	Y	Vial and Lid Separated	250	5000
FCT516405	0.5	Natural	Self-Standing	Yellow	N	Y	Vial and Lid Separated	250	5000
FCT516505	0.5	Natural	Self-Standing	Green	N	Y	Vial and Lid Separated	250	5000
FCT526705	0.5	Brown	Self-Standing	Brown	N	Y	Vial and Lid Separated	250	5000
FCT611005	0.5	Natural	Conical	Natural	N	N	Bag	50	5000
FCT611105	0.5	Natural	Conical	Red	N	N	Bag	50	5000
FCT611205	0.5	Natural	Conical	Orange	N	N	Bag	50	5000
FCT611305	0.5	Natural	Conical	Blue	N	N	Bag	50	5000
FCT611405	0.5	Natural	Conical	Yellow	N	N	Bag	50	5000
FCT611505	0.5	Natural	Conical	Green	N	N	Bag	50	5000
FCT611605	0.5	Natural	Conical	Pink	N	N	Bag	50	5000
FCT611705	0.5	Natural	Conical	Brown	N	N	Bag	50	5000
FCT611805	0.5	Natural	Conical	White	N	N	Bag	50	5000
FCT611905	0.5	Natural	Conical	Black	N	N	Bag	50	5000
FCT612005	0.5	Natural	Conical	Natural	N	Y	Bag	50	5000
FCT612105	0.5	Natural	Conical	Red	N	Y	Bag	50	5000
FCT612205	0.5	Natural	Conical	Orange	N	Y	Bag	50	5000
FCT612305	0.5	Natural	Conical	Blue	N	Y	Bag	50	5000
FCT612405	0.5	Natural	Conical	Yellow	N	Y	Bag	50	5000
FCT612505	0.5	Natural	Conical	Green	N	Y	Bag	50	5000
FCT612605	0.5	Natural	Conical	Pink	N	Y	Bag	50	5000
FCT612705	0.5	Natural	Conical	Brown	N	Y	Bag	50	5000
FCT612805	0.5	Natural	Conical	White	N	Y	Bag	50	5000
FCT612905	0.5	Natural	Conical	Black	N	Y	Bag	50	5000
FCT613005	0.5	Natural	Conical	Natural	N	Y	Vial and Lid Separated	500	5000

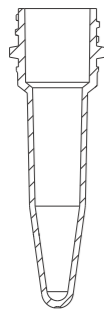
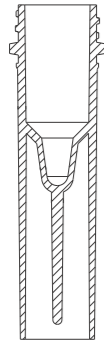

1.8mL Cryogenic Vials with Flat Cap

Cat. No.	Capacity (mL)	Vial Color	Bottom	Lid Color	Graduation Line	Sterile	Package	Qty.Per Bag	Qty.Per Case
FCT001018	1.8	Natural	Self-Standing	Red	Y	Y	Bag	20	5000

1.5mL Cryogenic Vials with Flat Cap

Cat. No.	Capacity (mL)	Vial Color	Bottom	Lid Color	Graduation Line	Sterile	Package	Qty.Per Bag	Qty.Per Case
FCT511015	1.5	Natural	Self-Standing	Natural	N	N	Bag	50	5000
FCT511115	1.5	Natural	Self-Standing	Red	N	N	Bag	50	5000
FCT511215	1.5	Natural	Self-Standing	Orange	N	N	Bag	50	5000
FCT511315	1.5	Natural	Self-Standing	Blue	N	N	Bag	50	5000
FCT511415	1.5	Natural	Self-Standing	Yellow	N	N	Bag	50	5000
FCT511515	1.5	Natural	Self-Standing	Green	N	N	Bag	50	5000
FCT511615	1.5	Natural	Self-Standing	Pink	N	N	Bag	50	5000
FCT511715	1.5	Natural	Self-Standing	Brown	N	N	Bag	50	5000
FCT511815	1.5	Natural	Self-Standing	White	N	N	Bag	50	5000
FCT511915	1.5	Natural	Self-Standing	Black	N	N	Bag	50	5000
FCT512015	1.5	Natural	Self-Standing	Natural	N	Y	Bag	50	5000
FCT512115	1.5	Natural	Self-Standing	Red	N	Y	Bag	50	5000
FCT512215	1.5	Natural	Self-Standing	Orange	N	Y	Bag	50	5000
FCT512315	1.5	Natural	Self-Standing	Blue	N	Y	Bag	50	5000
FCT512415	1.5	Natural	Self-Standing	Yellow	N	Y	Bag	50	5000
FCT512515	1.5	Natural	Self-Standing	Green	N	Y	Bag	50	5000
FCT512615	1.5	Natural	Self-Standing	Pink	N	Y	Bag	50	5000
FCT512715	1.5	Natural	Self-Standing	Brown	N	Y	Bag	50	5000
FCT512815	1.5	Natural	Self-Standing	White	N	Y	Bag	50	5000
FCT512915	1.5	Natural	Self-Standing	Black	N	Y	Bag	50	5000
FCT522815	1.5	Natural	Self-Standing	White	N	Y	Bag	500	5000
FCT516015	1.5	Natural	Self-Standing	Natural	N	Y	Vial and Lid Separated	250	5000
FCT516115	1.5	Natural	Self-Standing	Red	N	Y	Vial and Lid Separated	250	5000
FCT516215	1.5	Natural	Self-Standing	Orange	N	Y	Vial and Lid Separated	250	5000
FCT516315	1.5	Natural	Self-Standing	Blue	N	Y	Vial and Lid Separated	250	5000
FCT516415	1.5	Natural	Self-Standing	Yellow	N	Y	Vial and Lid Separated	250	5000
FCT516515	1.5	Natural	Self-Standing	Green	N	Y	Vial and Lid Separated	250	5000
FCT516615	1.5	Natural	Self-Standing	Pink	N	Y	Vial and Lid Separated	250	5000
FCT516715	1.5	Natural	Self-Standing	Brown	N	Y	Vial and Lid Separated	250	5000
FCT516815	1.5	Natural	Self-Standing	White	N	Y	Vial and Lid Separated	250	5000
FCT516915	1.5	Natural	Self-Standing	Black	N	Y	Vial and Lid Separated	250	5000
FCT526715	1.5	Brown	Self-Standing	Brown	N	Y	Vial and Lid Separated	250	5000
FCT611015	1.5	Natural	Conical	Natural	Y	N	Bag	50	5000
FCT611115	1.5	Natural	Conical	Red	Y	N	Bag	50	5000
FCT611215	1.5	Natural	Conical	Orange	Y	N	Bag	50	5000
FCT611315	1.5	Natural	Conical	Blue	Y	N	Bag	50	5000
FCT611415	1.5	Natural	Conical	Yellow	Y	N	Bag	50	5000
FCT611515	1.5	Natural	Conical	Green	Y	N	Bag	50	5000
FCT611615	1.5	Natural	Conical	Pink	Y	N	Bag	50	5000
FCT611715	1.5	Natural	Conical	Brown	Y	N	Bag	50	5000
FCT611815	1.5	Natural	Conical	White	Y	N	Bag	50	5000
FCT611915	1.5	Natural	Conical	Black	Y	N	Bag	50	5000
FCT613015	1.5	Natural	Conical	Natural	Y	N	Vial and Lid Separated	500	5000
FCT614015	1.5	Natural	Conical	Red	Y	N	Vial and Lid Separated	500	5000
FCT615015	1.5	Natural	Conical	Yellow	Y	N	Vial and Lid Separated	500	5000
FCT616015	1.5	Natural	Conical	Blue	Y	N	Vial and Lid Separated	500	5000
FCT617015	1.5	Natural	Conical	Green	Y	N	Vial and Lid Separated	500	5000
FCT618015	1.5	Natural	Conical	Brown	Y	N	Vial and Lid Separated	500	5000
FCT612015	1.5	Natural	Conical	Natural	Y	Y	Bag	50	5000
FCT612115	1.5	Natural	Conical	Red	Y	Y	Bag	50	5000
FCT612215	1.5	Natural	Conical	Orange	Y	Y	Bag	50	5000
FCT612315	1.5	Natural	Conical	Blue	Y	Y	Bag	50	5000
FCT612415	1.5	Natural	Conical	Yellow	Y	Y	Bag	50	5000
FCT612515	1.5	Natural	Conical	Green	Y	Y	Bag	50	5000
FCT612615	1.5	Natural	Conical	Pink	Y	Y	Bag	50	5000
FCT612715	1.5	Natural	Conical	Brown	Y	Y	Bag	50	5000
FCT612815	1.5	Natural	Conical	White	Y	Y	Bag	50	5000
FCT612915	1.5	Natural	Conical	Black	Y	Y	Bag	50	5000
FCT622015	1.5	Natural	Conical	Natural	Y	Y	Bag	500	5000

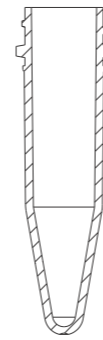
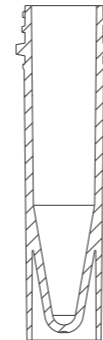

2.0mL Cryogenic Vials with Flat Cap

Cat. No.	Capacity (mL)	Vial Color	Bottom	Lid Color	Graduation Line	Sterile	Package	Qty.Per Bag	Qty.Per Case
FCT511020	2.0	Natural	Self-Standing	Natural	Y	N	Bag	50	5000
FCT511120	2.0	Natural	Self-Standing	Red	Y	N	Bag	20	5000
FCT511220	2.0	Natural	Self-Standing	Orange	Y	N	Bag	20	5000
FCT511320	2.0	Natural	Self-Standing	Blue	Y	N	Bag	20	5000
FCT511420	2.0	Natural	Self-Standing	Yellow	Y	N	Bag	20	5000
FCT511520	2.0	Natural	Self-Standing	Green	Y	N	Bag	20	5000
FCT511620	2.0	Natural	Self-Standing	Pink	Y	N	Bag	20	5000
FCT511720	2.0	Natural	Self-Standing	Brown	Y	N	Bag	20	5000
FCT511820	2.0	Natural	Self-Standing	White	Y	N	Bag	20	5000
FCT511920	2.0	Natural	Self-Standing	Black	Y	N	Bag	20	5000
FCT511820-1	2.0	Natural	Self-Standing	White	Y	N	Vial and Lid Separated	1000	5000
FCT512020	2.0	Natural	Self-Standing	Natural	Y	Y	Bag	20	5000
FCT512120	2.0	Natural	Self-Standing	Red	Y	Y	Bag	20	5000
FCT512220	2.0	Natural	Self-Standing	Orange	Y	Y	Bag	20	5000
FCT512320	2.0	Natural	Self-Standing	Blue	Y	Y	Bag	20	5000
FCT512420	2.0	Natural	Self-Standing	Yellow	Y	Y	Bag	20	5000
FCT512520	2.0	Natural	Self-Standing	Green	Y	Y	Bag	20	5000
FCT512620	2.0	Natural	Self-Standing	Pink	Y	Y	Bag	20	5000
FCT512720	2.0	Natural	Self-Standing	Brown	Y	Y	Bag	20	5000
FCT512820	2.0	Natural	Self-Standing	White	Y	Y	Bag	20	5000
FCT512920	2.0	Natural	Self-Standing	Black	Y	Y	Bag	20	5000
FCT522020	2.0	Natural	Self-Standing	Natural	Y	Y	Bag	500	5000
FCT522120	2.0	Natural	Self-Standing	Red	Y	Y	Bag	500	5000
FCT522320	2.0	Natural	Self-Standing	Blue	Y	Y	Bag	500	5000
FCT811020	2.0	Natural	Self-Standing	Purple	Y	Y	Bag	500	5000
FCT512020-1	2.0	Natural	Self-Standing	Natural	Y	Y	Vial and Lid Separated	1000	5000
FCT512120-1	2.0	Brown	Self-Standing	Red	Y	Y	Vial and Lid Separated	1000	5000
FCT512320-1	2.0	Natural	Self-Standing	Blue	Y	Y	Vial and Lid Separated	1000	5000
FCT512420-1	2.0	Natural	Self-Standing	Yellow	Y	Y	Vial and Lid Separated	1000	5000
FCT512520-1	2.0	Natural	Self-Standing	Green	Y	Y	Vial and Lid Separated	1000	5000
FCT614020	2.0	Natural	Self-Standing	Natural	Y	Y	Vial and Lid Separated	500	5000
FCT711020	2.0	Natural	Self-Standing	Yellow	Y	Y	Vial and Lid Separated	500	5000
FCT712020	2.0	Natural	Self-Standing	Green	Y	Y	Vial and Lid Separated	500	5000
FCT713020	2.0	Natural	Self-Standing	Red	Y	Y	Vial and Lid Separated	500	5000
FCT714020	2.0	Natural	Self-Standing	White	Y	Y	Vial and Lid Separated	500	5000
FCT715020	2.0	Natural	Self-Standing	Pink	Y	Y	Vial and Lid Separated	500	5000
FCT716020	2.0	Natural	Self-Standing	Orange	Y	Y	Vial and Lid Separated	500	5000
FCT717020	2.0	Natural	Self-Standing	Black	Y	Y	Vial and Lid Separated	500	5000
FCT718020	2.0	Natural	Self-Standing	Blue	Y	Y	Vial and Lid Separated	500	5000
FCT516220	2.0	Natural	Self-Standing	Orange	Y	Y	Vial and Lid Separated	250	5000
FCT516320	2.0	Natural	Self-Standing	Blue	Y	Y	Vial and Lid Separated	250	5000
FCT516820	2.0	Natural	Self-Standing	White	Y	Y	Vial and Lid Separated	250	5000
FCT526720	2.0	Natural	Self-Standing	Brown	N	Y	Vial and Lid Separated	250	5000
FCT611020	2.0	Natural	Conical	Natural	Y	N	Bag	20	5000
FCT611120	2.0	Natural	Conical	Red	Y	N	Bag	20	5000
FCT611220	2.0	Natural	Conical	Orange	Y	N	Bag	20	5000
FCT611320	2.0	Natural	Conical	Blue	Y	N	Bag	20	5000
FCT611420	2.0	Natural	Conical	Yellow	Y	N	Bag	20	5000
FCT611520	2.0	Natural	Conical	Green	Y	N	Bag	20	5000
FCT611620	2.0	Natural	Conical	Pink	Y	N	Bag	20	5000
FCT611720	2.0	Natural	Conical	Brown	Y	N	Bag	20	5000
FCT611820	2.0	Natural	Conical	White	Y	N	Bag	20	5000
FCT611920	2.0	Natural	Conical	Black	Y	N	Bag	20	5000
FCT613020	2.0	Natural	Conical	Natural	Y	N	Vial and Lid Separated	500	5000
FCT612020	2.0	Natural	Conical	Natural	Y	Y	Bag	20	5000
FCT612120	2.0	Natural	Conical	Red	Y	Y	Bag	20	5000



Cat. No.	Capacity (mL)	Vial Color	Bottom	Lid Color	Graduation Line	Sterile	Package	Qty.Per Bag	Qty.Per Case
FCT612220	2.0	Natural	Conical	Orange	Y	Y	Bag	20	5000
FCT612320	2.0	Natural	Conical	Blue	Y	Y	Bag	20	5000
FCT612420	2.0	Natural	Conical	Yellow	Y	Y	Bag	20	5000
FCT612520	2.0	Natural	Conical	Green	Y	Y	Bag	20	5000
FCT612620	2.0	Natural	Conical	Pink	Y	Y	Bag	20	5000
FCT612720	2.0	Natural	Conical	Brown	Y	Y	Bag	20	5000
FCT612820	2.0	Natural	Conical	White	Y	Y	Bag	20	5000
FCT612920	2.0	Natural	Conical	Black	Y	Y	Bag	20	5000

5.0mL Cryogenic Vials with Flat Cap

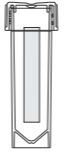

Cat. No.	Capacity (mL)	Vial Color	Bottom	Lid Color	O-Shaped Seal	Graduation Line	Sterile	Package	Qty.Per Bag	Qty.Per Case
FCT001150	5.0	Natural	Self-Standing	Green	Y	Y	Y	Bag	50	500
FCT001050	5.0	Natural	Self-Standing	Green	N	Y	Y	Bag	50	500
FCT002050	5.0	Natural	Self-Standing	Red	N	Y	Y	Bag	20	2500
FCT003050	5.0	Natural	Self-Standing	Green	N	Y	N	Vial and Lid Separated	2500	2500
FCT013050	5.0	Natural	Self-Standing	Green	N	Y	Y	Vial and Lid Separated	Lid:500 Vial:100	2500

0.5mL Cryogenic Vials with Concave Cap

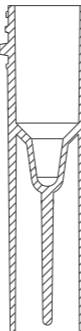

Cat. No.	Capacity (mL)	Vial Color	Bottom	Lid Color	Graduation Line	Sterile	Package	Qty.Per Bag	Qty.Per Case
FCT110005	0.5	Natural	Self-Standing	Natural	N	N	Box	100	1000
FCT111005	0.5	Natural	Self-Standing	Natural	N	Y	Box	100	1000
FCT362105	0.5	Natural	Self-Standing	Red	N	Y	Box	100	1000
FCT362305	0.5	Natural	Self-Standing	Blue	N	Y	Box	100	1000
FCT362405	0.5	Natural	Self-Standing	Yellow	N	Y	Box	100	1000
FCT362505	0.5	Natural	Self-Standing	Green	N	Y	Box	100	1000
FCT362605	0.5	Natural	Self-Standing	Pink	N	Y	Box	100	1000
FCT362805	0.5	Natural	Self-Standing	White	N	Y	Box	100	1000
FCT311005	0.5	Natural	Self-Standing	Natural	N	N	Box	50	5000
FCT311105	0.5	Natural	Self-Standing	Red	N	N	Bag	50	5000
FCT311305	0.5	Natural	Self-Standing	Blue	N	N	Bag	50	5000
FCT311405	0.5	Natural	Self-Standing	Yellow	N	N	Bag	50	5000
FCT311505	0.5	Natural	Self-Standing	Green	N	N	Bag	50	5000
FCT311605	0.5	Natural	Self-Standing	Pink	N	N	Bag	50	5000
FCT311705	0.5	Natural	Self-Standing	Brown	N	N	Bag	50	5000
FCT311805	0.5	Natural	Self-Standing	White	N	N	Bag	50	5000
FCT311905	0.5	Natural	Self-Standing	Black	N	N	Bag	50	5000
FCT312005	0.5	Natural	Self-Standing	Natural	N	Y	Bag	50	5000
FCT312105	0.5	Natural	Self-Standing	Red	N	Y	Bag	50	5000
FCT312305	0.5	Natural	Self-Standing	Blue	N	Y	Bag	50	5000
FCT312405	0.5	Natural	Self-Standing	Yellow	N	Y	Bag	50	5000
FCT312505	0.5	Natural	Self-Standing	Green	N	Y	Bag	50	5000
FCT312605	0.5	Natural	Self-Standing	Pink	N	Y	Bag	50	5000
FCT312705	0.5	Natural	Self-Standing	Brown	N	Y	Bag	50	5000
FCT312805	0.5	Natural	Self-Standing	White	N	Y	Bag	50	5000
FCT312905	0.5	Natural	Self-Standing	Black	N	Y	Bag	50	5000
FCT310005	0.5	Brown	Self-Standing	Natural	N	N	Bag	500	5000
FCT311205	0.5	Natural	Self-Standing	Natural	N	Y	Bag	500	5000
FCT510905	0.5	Brown	Self-Standing	Brown	N	N	Bag	500	5000
FCT513905	0.5	Brown	Self-Standing	Brown	N	Y	Bag	500	5000
FCT001005	0.5	Natural	Self-Standing	Natural	N	Y	Bag	50	5000
FCT315705	0.5	Natural	Self-Standing	Brown	N	Y	Vial and Lid Separated	250	5000
FCT315805	0.5	Natural	Self-Standing	White	N	Y	Vial and Lid Separated	250	5000



Cat. No.	Capacity (mL)	Vial Color	Bottom	Lid Color	Graduation Line	Sterile	Package	Qty. Per Bag	Qty. Per Case
FCT010005	0.5	Natural	Conical	Natural	N	N	Box	100	1000
FCT011005	0.5	Natural	Conical	Natural	N	Y	Box	100	1000
FCT112005	0.5	Natural	Conical	Natural	N	N	Bag	50	5000
FCT122005	0.5	Natural	Conical	Natural	N	Y	Bag	50	5000
FCT412905	0.5	Brown	Conical	Brown	N	N	Bag	50	5000
FCT422905	0.5	Brown	Conical	Brown	N	Y	Bag	50	5000
FCT210005	0.5	Natural	Conical	Natural	N	N	Bag	500	5000
FCT410905	0.5	Brown	Conical	Brown	N	N	Bag	500	5000
FCT411905	0.5	Brown	Conical	Brown	N	Y	Bag	500	5000
FCT002005	0.5	Natural	Conical	Natural	N	Y	Bag	50	5000

1.5mL Cryogenic Vials with Concave Cap

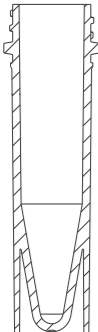

Cat. No.	Capacity (mL)	Vial Color	Bottom	Lid Color	Graduation Line	Sterile	Package	Qty. Per Bag	Qty. Per Case
FCT110015	1.5	Natural	Self-Standing	Natural	N	N	Box	100	1000
FCT111015	1.5	Natural	Self-Standing	Natural	N	Y	Box	100	1000
FCT362115	1.5	Natural	Self-Standing	Red	N	Y	Box	100	1000
FCT362315	1.5	Natural	Self-Standing	Blue	N	Y	Box	100	1000
FCT362415	1.5	Natural	Self-Standing	Yellow	N	Y	Box	100	1000
FCT362515	1.5	Natural	Self-Standing	Green	N	Y	Box	100	1000
FCT362615	1.5	Natural	Self-Standing	Pink	N	Y	Box	100	1000
FCT362815	1.5	Natural	Self-Standing	White	N	Y	Box	100	1000
FCT311015	1.5	Natural	Self-Standing	Natural	N	N	Bag	50	5000
FCT311115	1.5	Natural	Self-Standing	Red	N	N	Bag	50	5000
FCT311315	1.5	Natural	Self-Standing	Blue	N	N	Bag	50	5000
FCT311415	1.5	Natural	Self-Standing	Yellow	N	N	Bag	50	5000
FCT311515	1.5	Natural	Self-Standing	Green	N	N	Bag	50	5000
FCT311615	1.5	Natural	Self-Standing	Pink	N	N	Bag	50	5000
FCT311715	1.5	Natural	Self-Standing	Brown	N	N	Bag	50	5000
FCT311815	1.5	Natural	Self-Standing	White	N	N	Bag	50	5000
FCT311915	1.5	Natural	Self-Standing	Black	N	N	Bag	50	5000
FCT312015	1.5	Natural	Self-Standing	Natural	N	Y	Bag	50	5000
FCT312115	1.5	Natural	Self-Standing	Red	N	Y	Bag	50	5000
FCT312315	1.5	Natural	Self-Standing	Blue	N	Y	Bag	50	5000
FCT312415	1.5	Natural	Self-Standing	Yellow	N	Y	Bag	50	5000
FCT312515	1.5	Natural	Self-Standing	Green	N	Y	Bag	50	5000
FCT312615	1.5	Natural	Self-Standing	Pink	N	Y	Bag	50	5000
FCT312715	1.5	Natural	Self-Standing	Brown	N	Y	Bag	50	5000
FCT312815	1.5	Natural	Self-Standing	White	N	Y	Bag	50	5000
FCT312915	1.5	Natural	Self-Standing	Black	N	Y	Bag	50	5000
FCT310015	1.5	Brown	Self-Standing	Natural	N	N	Bag	500	5000
FCT311215	1.5	Natural	Self-Standing	Natural	N	Y	Bag	500	5000
FCT510915	1.5	Brown	Self-Standing	Brown	N	N	Bag	500	5000
FCT513915	1.5	Brown	Self-Standing	Brown	N	Y	Bag	500	5000
FCT001015	1.5	Natural	Self-Standing	Natural	N	Y	Bag	50	5000
FCT315015	1.5	Natural	Self-Standing	Natural	N	Y	Vial and Lid Separated	250	5000
FCT315115	1.5	Natural	Self-Standing	Red	N	Y	Vial and Lid Separated	250	5000
FCT315315	1.5	Natural	Self-Standing	Blue	N	Y	Vial and Lid Separated	250	5000
FCT315415	1.5	Natural	Self-Standing	Yellow	N	Y	Vial and Lid Separated	250	5000
FCT315515	1.5	Natural	Self-Standing	Green	N	Y	Vial and Lid Separated	250	5000
FCT315615	1.5	Natural	Self-Standing	Pink	N	Y	Vial and Lid Separated	250	5000
FCT010015	1.5	Natural	Conical	Natural	Y	N	Box	100	1000
FCT011015	1.5	Natural	Conical	Natural	Y	Y	Box	100	1000
FCT112015	1.5	Natural	Conical	Natural	Y	N	Bag	50	5000
FCT122015	1.5	Natural	Conical	Natural	Y	Y	Bag	50	5000
FCT412915	1.5	Brown	Conical	Brown	Y	N	Bag	50	5000
FCT422915	1.5	Brown	Conical	Brown	Y	Y	Bag	50	5000
FCT210015	1.5	Natural	Conical	Natural	Y	N	Bag	500	5000
FCT410915	1.5	Brown	Conical	Brown	Y	N	Bag	500	5000
FCT411915	1.5	Brown	Conical	Brown	Y	Y	Bag	500	5000

2.0mL Cryogenic Vials with Concave Cap

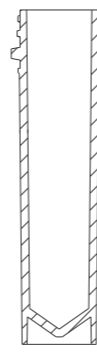

Cat. No.	Capacity (mL)	Vial Color	Bottom	Lid Color	Graduation Line	Sterile	Package	Qty. Per Bag	Qty. Per Case
FCT110020	2.0	Natural	Self-Standing	Natural	Y	N	Box	100	1000
FCT111020	2.0	Natural	Self-Standing	Natural	Y	Y	Box	100	1000
FCT111120	2.0	Natural	Self-Standing	Red	Y	Y	Box	100	1000
FCT111320	2.0	Natural	Self-Standing	Blue	Y	Y	Box	100	1000
FCT111420	2.0	Natural	Self-Standing	Yellow	Y	Y	Box	100	1000
FCT111520	2.0	Natural	Self-Standing	Green	Y	Y	Box	100	1000
FCT111620	2.0	Natural	Self-Standing	Pink	Y	Y	Box	100	1000
FCT111820	2.0	Natural	Self-Standing	White	Y	Y	Box	100	1000
FCT311020	2.0	Natural	Self-Standing	Natural	Y	N	Bag	20	5000
FCT311120	2.0	Natural	Self-Standing	Red	Y	N	Bag	20	5000
FCT311320	2.0	Natural	Self-Standing	Blue	Y	N	Bag	20	5000
FCT311420	2.0	Natural	Self-Standing	Yellow	Y	N	Bag	20	5000
FCT311520	2.0	Natural	Self-Standing	Green	Y	N	Bag	20	5000
FCT311620	2.0	Natural	Self-Standing	Pink	Y	N	Bag	20	5000
FCT311720	2.0	Natural	Self-Standing	Brown	Y	N	Bag	20	5000
FCT311820	2.0	Natural	Self-Standing	White	Y	N	Bag	20	5000
FCT311920	2.0	Natural	Self-Standing	Black	Y	N	Bag	20	5000
FCT312020	2.0	Natural	Self-Standing	Natural	Y	Y	Bag	20	5000
FCT312120	2.0	Natural	Self-Standing	Red	Y	Y	Bag	20	5000
FCT312320	2.0	Natural	Self-Standing	Blue	Y	Y	Bag	20	5000
FCT312420	2.0	Natural	Self-Standing	Yellow	Y	Y	Bag	20	5000
FCT312520	2.0	Natural	Self-Standing	Green	Y	Y	Bag	20	5000
FCT312620	2.0	Natural	Self-Standing	Pink	Y	Y	Bag	20	5000
FCT312720	2.0	Natural	Self-Standing	Brown	Y	Y	Bag	20	5000
FCT312820	2.0	Natural	Self-Standing	White	Y	Y	Bag	20	5000
FCT312920	2.0	Natural	Self-Standing	Black	Y	Y	Bag	20	5000
FCT310020	2.0	Natural	Self-Standing	Natural	Y	N	Bag	500	5000
FCT311220	2.0	Natural	Self-Standing	Natural	Y	Y	Bag	500	5000
FCT510920	2.0	Brown	Self-Standing	Brown	Y	N	Bag	500	5000
FCT513920	2.0	Brown	Self-Standing	Brown	Y	Y	Bag	500	5000
FCT315020	2.0	Natural	Self-Standing	Natural	Y	Y	Vial and Lid Separated	250	5000
FCT315520	2.0	Natural	Self-Standing	Green	Y	Y	Vial and Lid Separated	250	5000
FCT315620	2.0	Natural	Self-Standing	Pink	Y	Y	Vial and Lid Separated	250	5000
FCT315720	2.0	Natural	Self-Standing	Natural	Y	Y	Vial and Lid Separated	250	5000
FCT315820	2.0	Natural	Self-Standing	White	Y	Y	Vial and Lid Separated	250	5000
FCT010020	2.0	Natural	Conical	Natural	Y	N	Box	100	1000
FCT011020	2.0	Natural	Conical	Natural	Y	Y	Box	100	1000
FCT112020	2.0	Natural	Conical	Natural	Y	N	Bag	20	5000
FCT122020	2.0	Natural	Conical	Natural	Y	Y	Bag	20	5000
FCT412920	2.0	Brown	Conical	Brown	Y	N	Bag	20	5000
FCT422920	2.0	Brown	Conical	Brown	Y	Y	Bag	20	5000
FCT210020	2.0	Natural	Conical	Natural	Y	N	Bag	500	5000
FCT410920	2.0	Brown	Conical	Brown	Y	N	Bag	500	5000
FCT411920	2.0	Brown	Conical	Brown	Y	Y	Bag	500	5000

Cryogenic Vial Inserts



Cat. No.	Color	Sterile	Qty. Per Bag/Box	Qty. Per Case
FTC000001	Natural	N	500	5000
FTC000002	White	N	500	5000
FTC000003	Green	N	500	5000
FTC000004	Blue	N	500	5000



Stock Code: 688026

Bioprocess



In recent decades, with the continuous innovation and rapid development of life science and technology, the science of human life and medical science have gradually become more dependent on biological products. The traditional method of extracting biological products from animal tissues by biochemical technologies is no longer able to meet market demands, and therefore, a new technology prevails in the current days in which cells are extracted from animal tissues and cultured on a large scale in vitro to produce mAbs, specific proteins, IFNs and viral vaccines, and cellular therapy products.

Adhering to the spirit of innovation, JET BIOFIL focuses on the R&D of core technologies and has developed a series of biotechnical R&D instruments for bioprocess, such as multi-layer cell culture systems, multi-layer cell culture flasks and large-capacity erlenmeyer flasks, which not only save time, space, and manpower required for bioprocesses, but also minimize the risk of contamination. All products are DNase/RNase and pyrogen-free, non-cytotoxic and produced in a Class 100,000 clean workshop in strict accordance with ISO 9001:2015 and ISO 13485:2016 using high-quality raw materials that conform to USP Class VI standards. They have shown stable performance when subjected to cell line testing and strict quality validation. In addition, biosafety test and biocompatibility test reports provided by a third party are available to meet the demand for high quality in bioprocesses.

CellFac® Multi-Layer Cell Culture System

The CellFac® Multi-Layer cell culture systems are made of the medical-grade polymers. National patent numbers of product structure: ZL201220167380.4 & ZL201220167162.0.

It features a large cell growth surface area, which allows for high cell growth density and a large number of cells to be cultivated and harvested each time. The device offers significant savings in terms of materials, labor costs and time required for repeated rounds of cultivation. It also avoids the risk of cell contamination when adding liquids or performing inoculation and cell harvesting. The device has been widely applied to large-scale cell cultures and production of various biological products (such as vaccines, monoclonal antibodies, and virus packaging). It can be used for scientific research, laboratory-scale production and small/medium industrial production.

The JET BIOFIL CellFac® Multi-Layer cell culture systems are produced in a Class 100,000 cleanroom, with production quality managed in strict accordance with GMP standards. Safe and mature production techniques are used to ensure each process undergoes stringent validation. Based on third-party test results, all key indicators for finished products, such as extractables, biological compatibility and bio-safety are compliant with the standards including the Chinese Pharmacopeia, ISO, and USP.

- ◎ Specification: 1 layer 2 layers 5 layers 10 layers 40 layers
- ◎ Cap Type: Plug Seal Vent
- ◎ Surface: TC-treated Non-treated CellATTACH®-treated
- ◎ Materials: Bottle: Polystyrene (PS), Bottle Cap: High-density Polyethylene (HDPE), Filter Membrane: Polytetrafluoroethylene (PTFE), conforming to USP Class VI standards

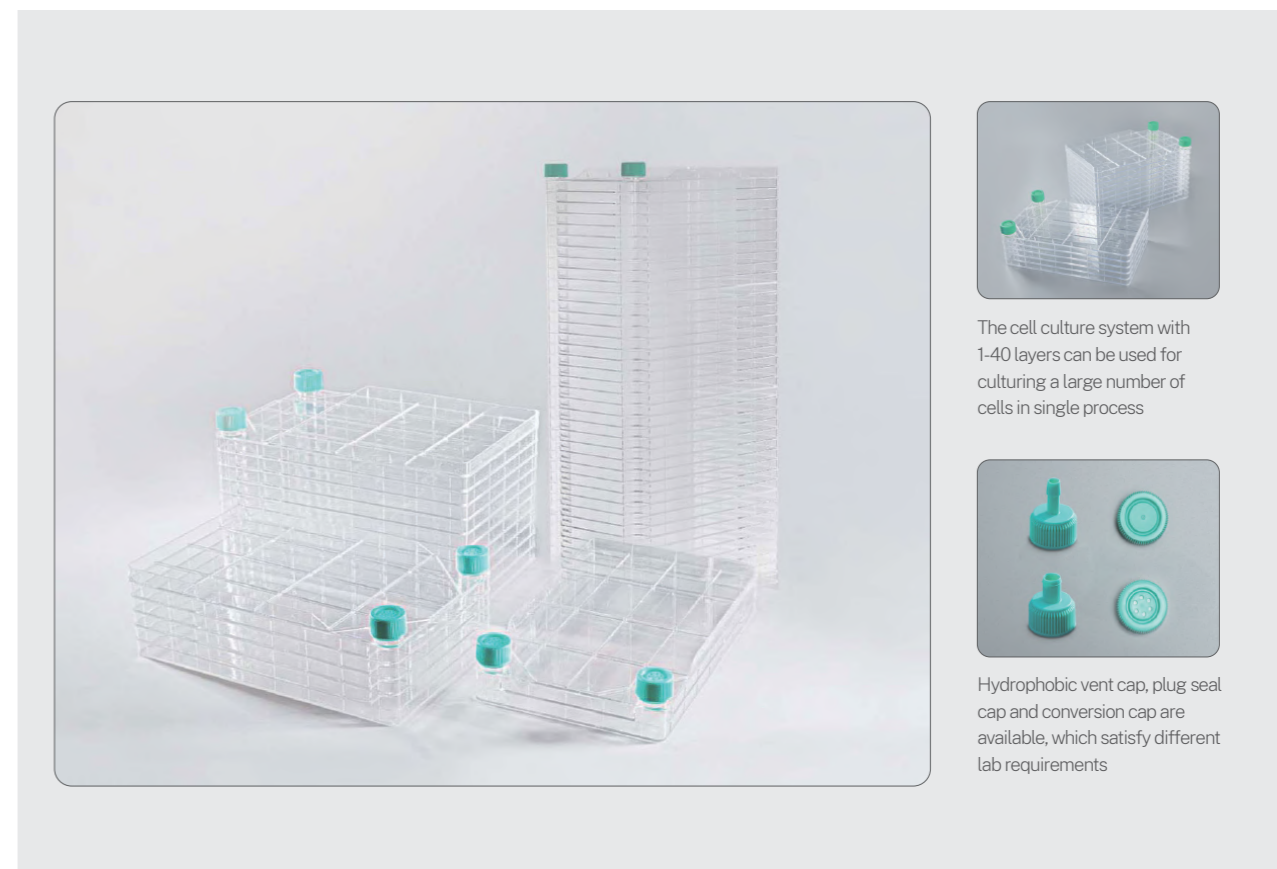

Features

- The cell culture systems are made of medical-grade polymers and produced in a dedicated cleanroom conforming to GMP standards
- Suitable for batch proliferation culture of adherent cells. Different specifications are available to satisfy different experimental demands
- Advanced ultrasonic welding techniques ensure high mechanical strength, while the absence of additives reduces the generation of unknown soluble substances and welding impurities
- Even, stable surface processes ensure an optimal culture environment for high-yield cell cultures
- 0.22 µm hydrophobic and ventilated vent cap ensures sterility and facilitates continuous gas exchange
- All channels within the cell culture system are large in size, enabling faster medium distribution and reducing the appearance of foams
- Accessories are easy to use and include a plug seal cap, vent cap and adapter, facilitating operation and reducing costs
- Every system is printed with lot No. for quality traceability
- Sterilized by irradiation, SAL 10⁻⁶
- DNase/RNase-free, non-pyrogenic, non-cytotoxic

Cat. No.	Type	Growth Surface Area (cm ²)	Working Volume (mL)	Sterile	Cap	Characteristic Description	Qty. Per Bag	Qty. Per Case
UCF010001	1 layer	656	130-200	Y	Φ33 mm vent cap, 0.22 µm hydrophobic membrane	Non-treated	1	8
UCF010002	2 layers	1296	260-400	Y			1	6
UCF010005	5 layers	3216	650-1000	Y			1	4
UCF010010	10 layers	6416	1300-2000	Y			1	2
UCF010040	40 layers	25600	5200-8000	Y	Φ33 mm vent cap, 0.22 µm hydrophobic membrane	TC-treated	1	2
UCF011001	1 layer	656	130-200	Y			1	8
UCF011002	2 layers	1296	260-400	Y			1	6
UCF011005	5 layers	3216	650-1000	Y			1	4
UCF011010	10 layers	6416	1300-2000	Y			1	2
UCF011040	40 layers	25600	5200-8000	Y			1	2

Guidelines For Use

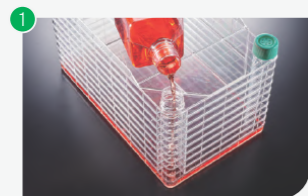

Unscrew the cap and slowly pour the medium into the Multi-Layer Cell Culture System, and tighten the cap



Slowly place the Multi-Layer Cell Culture System on its side toward the inlet to balance the liquid level

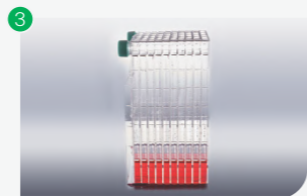

Slowly turn over the Multi-Layer Cell Culture System 90° with the inlet side on top, and the medium will be distributed evenly into each layer after standing



Holding the inlet side with your hands, slowly tilt the Multi-Layer Cell Culture System until it is in a horizontal position, and place it in the cell culture incubator

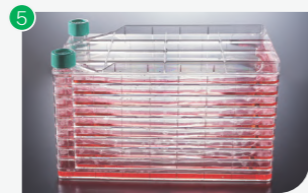

During cell culture, keep it horizontal



When the culture is complete, loosen the cap and carefully pour the medium into a bottle to collect the cells

Jet CellFac® Multi-Layer Cell Culture System Accessories



Vent Cap

Cat. No.	Description
UCF412002	Sterile, 1 per/bag, 10 per/case



Sealing Cap

Cat. No.	Description
UCF411002	Sterile, 1 per/bag, 10 per/case



Large Hole Conversion Cover

Cat. No.	Description
UCF413002	Conversion cover, filter connection cover, connects to a hose with an inner diameter of 3 / 8 inch (9.5 mm), sterile, 10 pcs/bag, 10 pcs/carton



Small Hole Conversion Cover

Cat. No.	Description
UCF414002	Conversion cover, filter connection cover, big mouth to small mouth, 1 per/bag, 10 per/case



Hose Clamp

Cat. No.	Description
UCF418001	Clamps hoses with an outer diameter of 12 mm-18 mm, 1 per/bag, 10 per/case



Adapter

Cat. No.	Description
UCF415001	Connects with #17 hose and 30 mm filter, 1 per/bag, 10 per/case



Hose

Cat. No.	Description
UCF419001	3/8 inch (9.5 mm) inner diameter and 1/2 inch (12.7 mm) outer diameter



Hose

Cat. No.	Description
UCF421001	#17Hose



Filter Combination Cover

Cat. No.	Description
UCF416001	30 mm, PTFE 0.22 µm filter, # 17 hose, small port conversion cover, 1 set/bag, 1 bag/box



Filter Combination Cover

Cat. No.	Description
UCF417001	50 mm, PTFE 0.22 µm filter, 3 / 8 inch (9.5 mm) inner diameter hose, large mouth conversion cover, 1 set/bag, 1 bag/box



Syringe Driven Filter

Cat. No.	Description
PTF205030	30 mm, PTFE 0.2 µm



Syringe Driven Filter

Cat. No.	Description
PTF225050	50 mm, PTFE 0.2 µm

Erlenmeyer Flasks

As the ideal choice for suspension cell culture, Erlenmeyer flasks are used in the screening of industrial microbial strains, large-scale proliferation tests, and seed cultures. They can also be used for media preparation, mixing, storage, and other purposes. They are more cost-efficient than culture bottles, dishes and spinner bottles.

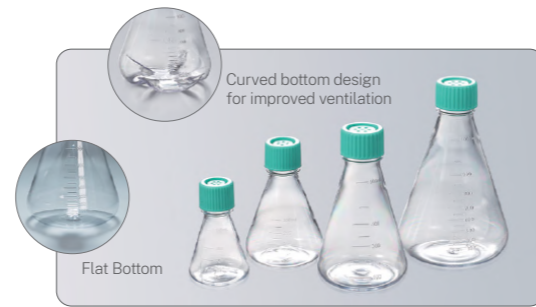

- Specification: 125 mL 250 mL 500 mL 1000 mL
- Bottom Type: Plain Baffled
- Cap Type: Plug Seal Vent
- Materials: Flask Body: Polycarbonate (PC)/Polyethylene terephthalate glycol (PETG), Bottle Cap: High-density polyethylene (HDPE), Cap Filter Membrane: Polytetrafluoroethylene (PTFE), conforming to USP Class VI standards

Features

- Even, transparent body features a clear and accurate graduation for volume observation
- Flask neck is lengthened for an easier grip. Liquid sticking-resistant design at the bottle neck enables easier pouring
- PC material supports autoclave sterilization for one time(repeated autoclaved sterilization is not recommended; autoclaved sterilization must not be performed for the permeable cap)
- Every flask is printed with lot No. for quality traceability
- 0.22 μm PTFE hydrophobic, permeable filter membrane cap ensures sterility and facilitates gas exchange
- PETG material shrinks under autoclave sterilization to reduce biohazard residue
- 100% passing rate for production line air tightness test to ensure no leakage occurs
- Sterilized by irradiation, SAL 10⁻⁶
- DNase/RNase-free, non-pyrogenic, non-cytotoxic

Erlenmeyer Flask with Plain Bottom

Cat. No.	Specification (mL)	Material of Bottle Body	Cap Type	Sterile	Qty. Per Bag	Qty. Per Case
TAB101125	125	PETG	Plug Seal	Y	1	24
TAB102125	125	PETG	Vent	Y	1	24
TAB101250	250	PETG	Plug Seal	Y	1	12
TAB102250	250	PETG	Vent	Y	1	12
TAB101500	500	PETG	Plug Seal	Y	1	12
TAB102500	500	PETG	Vent	Y	1	12
TAB101000	1000	PETG	Plug Seal	Y	1	24
TAB102000	1000	PETG	Vent	Y	1	24
TAB001125	125	PC	Plug Seal	Y	1	24
TAB002125	125	PC	Vent	Y	1	24
TAB001250	250	PC	Plug Seal	Y	1	12
TAB002250	250	PC	Vent	Y	1	12
TAB001500	500	PC	Plug Seal	Y	1	12
TAB002500	500	PC	Vent	Y	1	12
TAB001000	1000	PC	Plug Seal	Y	1	24
TAB002000	1000	PC	Vent	Y	1	24

Erlenmeyer Flask with Baffled Bottom

Cat. No.	Specification (mL)	Material of Bottle Body	Cap Type	Sterile	Qty. Per Bag	Qty. Per Case
TAB111125	125	PETG	Plug Seal	Y	1	24
TAB112125	125	PETG	Vent	Y	1	24
TAB111250	250	PETG	Plug Seal	Y	1	12
TAB112250	250	PETG	Vent	Y	1	12
TAB111500	500	PETG	Plug Seal	Y	1	12
TAB112500	500	PETG	Vent	Y	1	12
TAB111000	1000	PETG	Plug Seal	Y	1	24
TAB112000	1000	PETG	Vent	Y	1	24
TAB011125	125	PC	Plug Seal	Y	1	24
TAB012125	125	PC	Vent	Y	1	24
TAB011250	250	PC	Plug Seal	Y	1	12
TAB012250	250	PC	Vent	Y	1	12
TAB011500	500	PC	Plug Seal	Y	1	12
TAB012500	500	PC	Vent	Y	1	12
TAB011000	1000	PC	Plug Seal	Y	1	24
TAB012000	1000	PC	Vent	Y	1	24

Large-capacity Erlenmeyer Flasks

Large-capacity erlenmeyer flasks are mainly used for large-scale expansion and culture of suspension cells and bacteria, etc., as well as for preparation, storage and transfer of culture medium. Because large-capacity erlenmeyer flasks can greatly improve cultivation efficiency, they have been widely used in cell biology, microbiology and other fields.

- Specification : 2 L 3 L 5 L 5 L (with handle)
- Cap style : Plug Seal Cap Vent Cap
- Materials: Flask body: Polycarbonate (PC), Flask cap: High-density polyethylene (HDPE), Filter membrane polytetrafluoroethylene (PTFE), conforming to USP Class VI standards

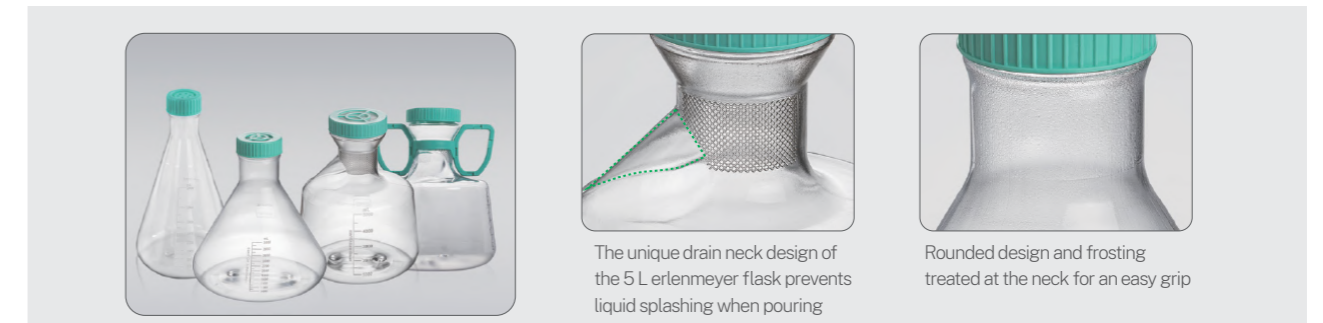

Features

- The flask body is made of polycarbonate (PC) material that has high transparency, strong impact resistance and high temperature resistance of up to 121°C.
- Engraved graduation and clear and accurate scale line make it easy to observe the capacity.
- The circular arc design at the flask neck and the frosting process treatment enable an easy grip, and the anti-drip design at the flask mouth enables easy pouring.
- The unique drain neck design of the 5 L erlenmeyer flask prevents liquid splashing when pouring.
- Optional handles are available for the 5 L Erlenmeyer flask for easy access.
- The bottom of the flask is fully flat and can be stably placed on a tabletop shaker to effectively control the amount of foam.
- 0.22 μm PTFE hydrophobic and breathable vent cap facilitates continuous gas exchange while ensuring sterility and preventing leakage.
- Subjected to strict sealing, drop, flatness and other series of tests to ensure product quality.
- Indication of batch number on each product package to ensure quality traceability.
- Sterilized by irradiation, SAL 10⁻⁶.
- DNase/RNase-free, non-pyrogenic and non-cytotoxicity.

Cat. No.	Capacity	Material of Flask Body	Type of Cap	Sterile	Qty. Per Bag	Qty. Per Case
TAB001002	2 L	PC	Plug Seal	Y	1	6
TAB002002	2 L	PC	Vent	Y	1	6
TAB001003	3 L	PC	Plug Seal	Y	1	4
TAB002003	3 L	PC	Vent	Y	1	4
TAB001005	5 L	PC	Plug Seal	Y	1	4
TAB002005	5 L	PC	Vent	Y	1	4
TAB502005	5 L(with handle)	PC	Vent	Y	1	4

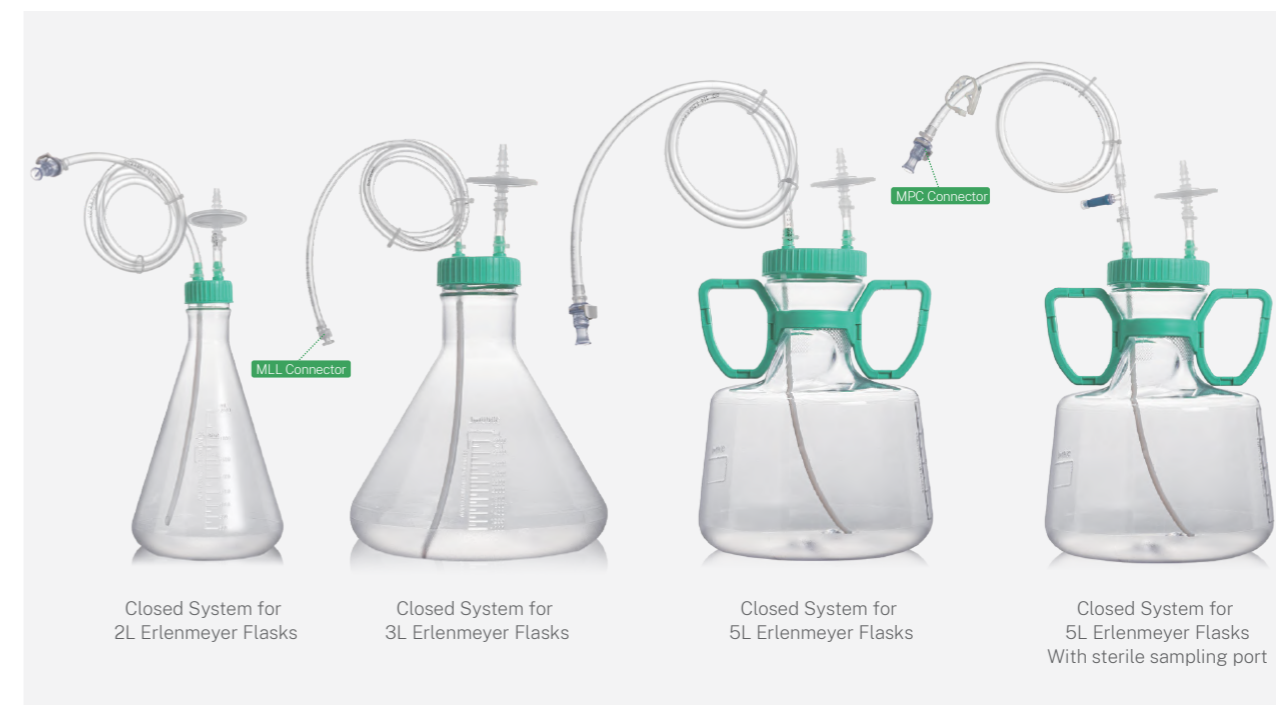

Features

- The closed transfer system can effectively reduce the risk of contamination in the process of liquid transfer
- The medical triple bagged package conforming to higher cleanliness requirement under the GMP production
- The inner tube can be extended to the bottom of the bottle to complete liquid transfer. The length and aperture of the tube can also be customized
- The bottle cap is connected by injection molding to reduce the risk of leakage and residue
- MPC connector and MLL connector are available to meet the different types of tube connections
- The closed transfer system of 5 L erlenmeyer flasks is equipped with a three-way port for sterile sampling
- Sterilized by irradiation, SAL 10⁻⁶
- DNase/RNase-free, Pyrogenic free, non-cytotoxic

Cat. No.	Product Name	Tube (Inner and Outer Diameters)	Tube Connector	Filter	Length of Liquid Tube (cm)	Sterile	Qty. Per/Case
TAB300002	Sterile transfer cap of 2L culture flasks	Thermoplastic tube Tube diameter : 1/4" ID, 3/8" OD	MPC	PTFE, 0.22μm	120	Y	6
TAB310002	Sterile transfer cap of 2L culture flasks	Thermoplastic tube Tube diameter : 1/8" ID, 1/4" OD	MLL	PTFE, 0.22μm	120	Y	6
TAB300003	Sterile transfer cap of 3L culture flasks	Thermoplastic tube Tube diameter : 1/4" ID, 3/8" OD	MPC	PTFE, 0.22μm	120	Y	6
TAB310003	Sterile transfer cap of 3L culture flasks	Thermoplastic tube Tube diameter : 1/8" ID, 1/4" OD	MLL	PTFE, 0.22μm	120	Y	6
TAB300005	Sterile transfer cap of 5L culture flasks	Thermoplastic tube Tube diameter : 1/4" ID, 3/8" OD	MPC With sterile sampling port	PTFE, 0.22μm	100	Y	6
TAB320005	Sterile transfer cap of 5L culture flasks	Thermoplastic tube Tube diameter : 1/4" ID, 3/8" OD	MPC	PTFE, 0.22μm	100	Y	6

MLL male Luer connector with plug; MPC male MPC connector with plug

Closed System for Erlenmeyer Flasks

In the industrial production of biological products, it is very important to reduce the potential risk of contamination in the process of liquid transfer and sampling. JET BIOFIL closed transfer system for large-capacity erlenmeyer flasks is made of raw materials conforming to USP CLASS VI standard. It can be used with 2L/3L/5L large-capacity erlenmeyer flasks, and is widely used for liquid transfer and culture in large-scale amplification processes of suspension cells and bacteria to minimize the risk of contamination. Our products fully meet the requirements for liquid sterile transfer.



- Specifications of matching erlenmeyer flask: 2L, 3L, 5L
- Type of tube connector: MPC connector and MLL connector
- Material: Bottle cap (PE) Inner tube (PTFE) Outer tube (TPE) MLL connector (PP)/MPC connector (PC) Filter housing (PP) Filter membrane(PTFE)

Multi-layer Cell Culture Flasks

The multi-layer cell culture flasks are available in 3 or 5 layers, providing 525 cm² and 875 cm² cell growth surface area, respectively. They are equivalent to 3 and 5 times the surface area of a T-175 culture flask. The higher-capacity design makes cell culture faster, easier, and more efficient.

- Cap Type: Plug Seal Vent
- Surface: TC-treated CellATTACH®-treated
- Materials: Flask Body: Polystyrene (PS), Flask Cap: High-density Polyethylene (HDPE)
Filter Membrane: Polytetrafluoroethylene (PTFE), conforming to USP Class VI standards

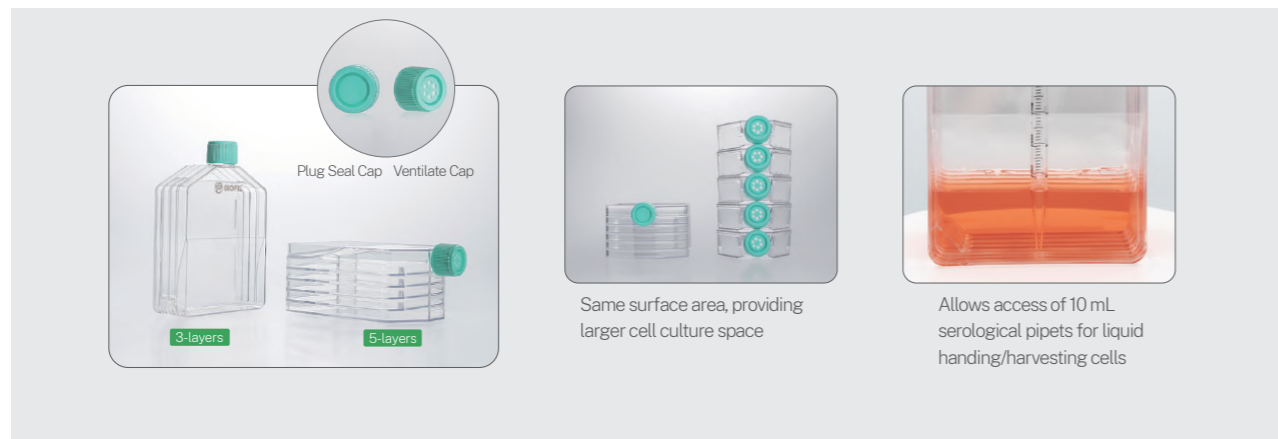

Features

- The medium can be evenly distributed across each layer, providing a consistent culture environment for uniform cell growth
- Every flask is printed with the lot No. for quality traceability
- Cells and reagents can be mixed directly in the flask, with no leakage or splash between layers, saving time and reducing the risk of contamination
- Suitable for 10 mL serological pipets for liquid aspiration/replenishment or cells harvesting directly in the flask
- The surface treatment of each layer is uniform and stable, effectively guaranteeing scaled-up cell cultures
- Sterilized by irradiation, SAL 10⁻⁶
- DNase/RNase-free, Non-pyrogenic, Non-cytotoxic

Cat. No.	Layer	Surface	Cell Growth Area (cm ²)	Type of Cap	Dimensions(mm)				Sterile	Qty. Per Bag	Qty. Per Case
					L	W	H	B.N.D			
TCF011525	3	TC-treated	525	Plug Seal	196.7	127.2	55.6	26	Y	2	12
TCF012525	3		Vent	196.7	127.2	55.6	26	Y	2	12	
TCF011875	5		Plug Seal	196.7	127.2	80.2	26	Y	1	8	
TCF012875	5		Vent	196.7	127.2	80.2	26	Y	1	8	
CAF011525	3	CellATTACH®-treated	525	Plug Seal	196.7	127.2	55.6	26	Y	2	12
CAF012525	3		Vent	196.7	127.2	55.6	26	Y	2	12	
CAF011875	5		Plug Seal	196.7	127.2	80.2	26	Y	1	8	
CAF012875	5		Vent	196.7	127.2	80.2	26	Y	1	8	

*Bottle Neck Diameter

Roller Bottles

Roller bottles are high-quality consumables that can meet the requirements of large-scale cell and tissue culture for experimental and industrial production. They are mainly used in laboratory cell research and in the industrial production of biological products, including recombinant proteins, monoclonal antibodies, virus vaccines, and cell secretions.

- Specification: 1000 mL 2000 mL 5000 mL
- Cap Type: Plug Seal Vent
- Surface: Non-treated TC-treated
- Materials: Bottle Body: Polystyrene (PS), Bottle Cap: High-density Polyethylene (HDPE), Cap Filter Membrane: Polytetrafluoroethylene (PTFE), conforming to USP Class VI standards

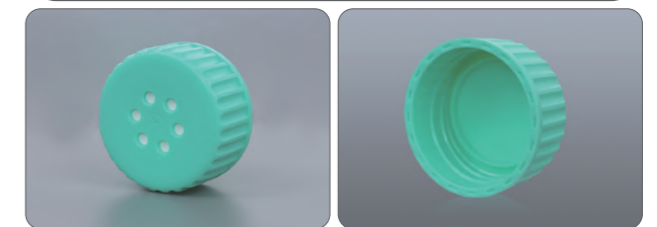

Features

- The lid is ergonomically designed with thick stripes for easy screwing, thereby improving efficiency
- Printed graduation marks facilitate easy recording
- Suitable for all common instruments and automation equipment
- Smooth and groove bottle surfaces are available. Groove surface bottles provide a larger culture area than smooth surface bottles with the same volume
- One-piece design, 100% passing rate for production line air tightness test to ensure no leakage occurs
- Every bottle is printed with the lot No. for quality traceability
- Sterilized by irradiation, SAL 10⁻⁶
- DNase/RNase-free, non-pyrogenic, non-cytotoxic

Roller Bottles, Non-treated

Cat. No.	Volume(mL)	Working Volume (mL)	Cap Style	Sterile	Qty. Per Pack	Qty. Per Case
TCB001001	1000	100-150	Plug seal	Y	1	24
TCB002001	1000	100-150	Vent	Y	1	24
TCB001002	2000	180-260	Plug seal	Y	1	12
TCB002002	2000	180-260	Vent	Y	1	12
TCB001102	2000	180-260	Easy grip plug seal	Y	1	12
TCB002102	2000	180-260	Easy grip vent	Y	1	12
TCB001005	5000	340-510	Plug seal	Y	1	12
TCB002005	5000	340-510	Vent	Y	1	12

Roller Bottles, TC-treated

Cat. No.	Volume (mL)	Appro. Cell Growth Area (cm ²)	Working Volume (mL)	Cap Style	Sterile	Qty. Per Pack	Qty. Per Case
TCB011001	1000	490	100-150	Plug seal	Y	1	24
TCB012001	1000	490	100-150	Vent	Y	1	24
TCB011002	2000	850	180-260	Plug seal	Y	1	12
TCB012002	2000	850	180-260	Vent	Y	1	12
TCB011102	2000	850	180-260	Easy grip plug seal	Y	1	12
TCB012102	2000	850	180-260	Easy grip vent	Y	1	12
TCB011005	5000	1700	340-510	Plug seal	Y	1	12
TCB012005	5000	1700	340-510	Vent	Y	1	12

Expanded Surface Roller Bottles, Non-treated

Cat. No.	Volume (mL)	Working Volume (mL)	Cap Style	Sterile	Qty. Per Pack	Qty. Per Case
TCB021002	2000	300-400	Plug seal	Y	1	12
TCB022002	2000	300-400	Vent	Y	1	12
TCB021005	5000	340-510	Plug seal	Y	1	12
TCB022005	5000	340-510	Vent	Y	1	12

Expanded Surface Roller Bottles, TC-treated

Cat. No.	Volume (mL)	Appro. Cell Growth Area (cm ²)	Working Volume (mL)	Cap Style	Sterile	Qty. Per Pack	Qty. Per Case
TCB031002	2000	1900	300-400	Plug seal	Y	1	12
TCB032002	2000	1900	300-400	Vent	Y	1	12
TCB031102	2000	1900	300-400	Easy grip plug seal	Y	1	12
TCB032102	2000	1900	300-400	Easy grip vent	Y	1	12
TCB031005	5000	4250	340-510	Plug seal	Y	1	12
TCB032005	5000	4250	340-510	Vent	Y	1	12



— Stock code: 688026 —

Liquid Handling and Storage



Liquid handling is an essential process that matters to results in both scientific experiments and industrial production. JET BIOFIL offers an extensive range of products for liquid handling and storage, including centrifuge tubes, pipettes, and tips. All these products are manufactured in Class 100,000 cleanrooms using high-quality raw materials that conform to USP Class VI standards. Rich in variety and specifications, they are compatible with a wide spectrum of products available on the market such as centrifuges, pipettes, and automated liquid-handling workstations. Non-pyrogenic and DNase/RNase-free, they are of superior quality and boast stable performance. You can choose your preferred products according to the volume of liquid to be handled and your needs in various experiments.

Centrifuge Tubes

The 15 mL and 50 mL centrifuge tubes are made of USP Class VI standards polypropylene (PP) and are suitable for laboratory centrifugation in various fields such as cell biology, immunology, microbiology and molecular biology, as well as for sample preparation and sample storage.

- ◎ Specification: 15 mL 50 mL
- ◎ Cap Type: Flat Plug Seal
- ◎ Bottom Type: Conical Self-standing
- ◎ Packaging: Re-sealable Bag Paper Rack Plastic Rack Bulk
- ◎ Materials: Tube Body: Polypropylene (PP), Tube Cap: High-density polyethylene (HDPE), conforming to USP Class VI standards



Features

- ◎ Easy-to-read black graduations and an accuracy within $\pm 2\%$
- ◎ The centrifuge tubes feature black printed graduations and a large white writing area resistant to alcohol wiping
- ◎ Maximum RCF: 12,000 $\times g$ (Conical tube), RCF: 6,000 $\times g$ (Self-standing tube)
- ◎ Working temperature range: -80°C – 121°C
- ◎ Tube Body Marked with Maximum Liquid Volume Indicator during Freezing
- ◎ Leak-proof
- ◎ Sterilized and non-sterilized available, sterilized by irradiation to SAL 10^{-6}
- ◎ DNase/RNase-free, non-pyrogenic

- ⚠ Warning: 1. Do not use foam racks for cryopreservation (-80°C – 20°C) of centrifuge tubes.
2. Loosen cap during autoclave sterilization

Centrifuge Tubes with Flat Cap

	Cat. No.	Capacity (mL)	Bottom	Sterile	Maximum RCF ($\times g$)	Package	Qty. Per Bag	Qty. Per Case
	CFT000150	15	Conical	N	12,000	Bulk	500	500
	CFT010150	15	Conical	N	12,000	Re-sealable bag	50	500
	CFT011150	15	Conical	Y	12,000	Re-sealable bag	25	500
	CFT021150	15	Conical	Y	12,000	Paper rack	25	500
	CFT031150	15	Conical	Y	12,000	Plastic Rack	25	300
	CFT000500	50	Conical	N	12,000	Bulk	500	500
	CFT010500	50	Conical	N	12,000	Re-sealable bag	50	500
	CFT011500	50	Conical	Y	12,000	Re-sealable bag	25	500
	CFT021500	50	Conical	Y	12,000	Paper rack	25	500
	CFT100500	50	Self-standing	N	6,000	Bulk	500	500
	CFT111500	50	Self-standing	Y	6,000	Re-sealable bag	25	500
	CFT110500	50	Self-standing	N	6,000	Re-sealable bag	50	500
	CFT031500	50	Conical	Y	12,000	Plastic Rack	25	300

Centrifuge Tubes with Plug Seal Cap

	Cat. No.	Capacity (mL)	Bottom	Cap Gasket	Sterile	Maximum RCF ($\times g$)	Package	Qty. Per Bag	Qty. Per Case
	CFT550150	15	Conical	N	N	12,000	Bulk	500	500
	CFT510150	15	Conical	N	N	12,000	Re-sealable bag	50	500
	CFT511150	15	Conical	N	Y	12,000	Re-sealable bag	25	500
	CFT521150	15	Conical	N	Y	12,000	Paper rack	25	500
	CFT621150	15	Conical	N	Y	12,000	Plastic Rack	25	300
	CFT522150	15	Conical	N	N	12,000	Paper rack	25	500
	CFT510500	50	Conical	N	N	12,000	Re-sealable bag	50	500
	CFT511500	50	Conical	N	Y	12,000	Re-sealable bag	25	500
	CFT521500	50	Conical	N	Y	12,000	Paper rack	25	500
	CFT621500	50	Conical	N	Y	12,000	Plastic Rack	25	300
	CFT660500	50	Self-standing	N	N	6,000	Bulk	500	500
	CFT610500	50	Self-standing	N	N	6,000	Re-sealable bag	50	500
	CFT611500	50	Self-standing	N	Y	6,000	Re-sealable bag	25	500
	CFT615500	50	Conical	Y	Y	12,000	Re-sealable bag	25	500
	CFT616500	50	Conical	Y	N	12,000	Paper rack	25	500
	CFT617500	50	Conical	Y	Y	12,000	Plastic Rack	25	500
	CFT656500	50	Conical	Y	N	12,000	Bulk	500	500
	CFT614500	50	Self-standing	Y	N	6,000	Bulk	500	500
	CFT613500	50	Self-standing	Y	Y	6,000	Re-sealable bag	25	500

Conical Centrifuge Bottles

The conical centrifuge bottles are economical laboratory consumables for large-capacity liquid centrifugation and are suitable for large-scale cell harvesting, as well as plasmid and protein purification. These products can help researchers reduce centrifugation cycles and increase efficiency in experiments and production.

- Specification: 225 mL 250 mL 500 mL
- Bottom Type: Conical
- Materials: Tube Body: Polypropylene (PP), Tube Cap: High-density polyethylene (HDPE), conforming to USP Class VI standards



Designed with an engraved scale on the outer wall, clear and easy to observe

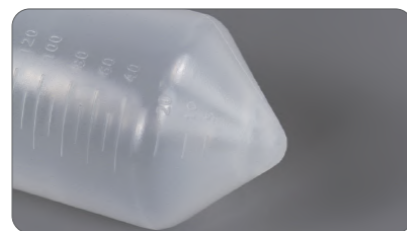

Conical bottom



Screw seal cap ensures no leakage

Features

- The bottle body is made of high-quality PP, which is resistant to high temperatures and high pressure, and has smooth inner and outer surfaces and a uniform gloss.
- Designed with an engraved scale on the outer wall for easy observation and calibration with an accuracy of $\pm 2\%$
- 225 mL/250 mL maximum RCF: 7,500xg, 500 mL maximum RCF: 6,000xg
- The screw seal cap has undergone strict production line sealing performance tests to ensure zero leakage
- Recommended liquid feeding volume: 80% of max graduated volume
- Working temperature range: -80°C - 121°C
- Sterilized by irradiation, SAL 10^{-6}
- DNase/RNase-free, non-pyrogenic

Cat. No.	Capacity (mL)	Maximum RCF (xg)	Size	Bottom	Sterile	Qty. Per Bag	Qty. Per Case
CFT012225	225	7,500g	61 mm*137 mm	Conical	Y	6	48
CFT012250	250	7,500g	61 mm*161 mm	Conical	Y	6	48
CFT013500	500	6,000g	95 mm*155 mm	Conical	Y	6	36
CFT041500	500	6,000g	95 mm*147 mm	Conical	Y	6	36

High-Performance Centrifuge Tubes

The high-performance centrifuge tubes are widely used in various experimental procedures, meeting the requirements of biological experiments. They comply with the ROHS standards, TSE/BSE risk statements, and do not contain latex components. The tubes are designed with a unique dual-color cap for better sealing. The tube body can withstand up to a -90Kpa negative pressure and a 20,000xg centrifugal force.

- Specification: 15 mL 50 mL
- Cap Type: Flat
- Bottom Type: Conical Self-standing
- Packaging: Re-sealable Bag Paper Rack
- Materials: Tube Body: Polypropylene (PP), Tube Cap: High-density polyethylene (HDPE), conforming to USP Class VI standards

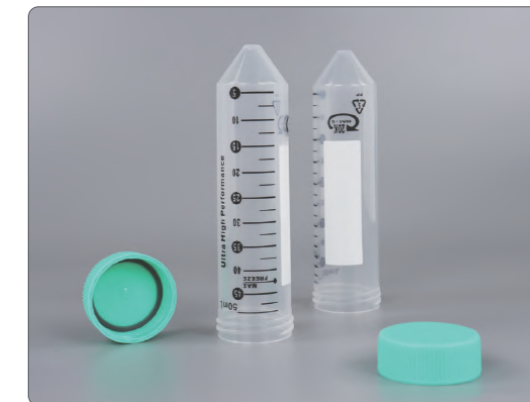

Cat. No.	Capacity (mL)	Bottom	Sterile	Maximum RCF (xg)	Package	Qty. Per Bag(Rack)	Qty. Per Case
CFT920150	15	Conical	Y	20,000	Paper rack	50	500
CFT921150	15	Conical	Y	20,000	Re-sealable bag	25	500
CFT925150	15	Conical	N	20,000	Re-sealable bag	50	500
CFT920500	50	Conical	Y	20,000	Paper rack	25	500
CFT921500	50	Conical	Y	20,000	Re-sealable bag	25	500
CFT925500	50	Conical	N	20,000	Re-sealable bag	50	500
CFT926500	50	Self-standing	Y	10,000	Re-sealable bag	50	500
CFT927500	50	Self-standing	N	10,000	Re-sealable bag	50	500

Light Sensitive Centrifuge Tubes

The 15 mL and 50 mL light sensitive centrifuge tubes are made of polypropylene (PP) conforming to USP Class VI standards and can block 100% of UV rays. They are designed for light-proof storage or centrifugation of light-sensitive samples.

- Specification: 15 mL 50 mL
- Cap Type: Plug seal
- Bottom Type: Conical
- Packaging: Re-sealable Bag Paper Rack
- Materials: Tube Body: Polypropylene (PP), Tube Cap: High-density polyethylene (HDPE), conforming to USP Class VI standards



Cat. No.	Capacity (mL)	Bottom	Sterile	Maximum RCF (×g)	Package	Qty. Per Bag	Qty. Per Case
CFT710150	15	Conical	N	12,500	Re-sealable bag	50	500
CFT71115	15	Conical	Y	12,500	Re-sealable bag	25	500
CFT712150	15	Conical	Y	12,500	Paper rack	25	500
CFT710500	50	Conical	N	12,500	Re-sealable bag	50	500
CFT711500	50	Conical	Y	12,500	Re-sealable bag	25	500
CFT712500	50	Conical	Y	12,500	Paper rack	25	500

High-RCF Centrifuge Tubes

The high-RCF centrifuge tubes are made of transparent polymer polypropylene (PP) material to withstand a centrifugal force of up to 21000×g. The products can be widely used in a variety of experimental operations to meet the requirements of biological experiments while preventing rupture and leakage during high-speed centrifugation.

- ◎ Specification: 15 mL 50 mL
- ◎ Cap Type: Flat
- ◎ Bottom Type: Conical
- ◎ Packaging: Re-sealable Bag Paper Rack
- ◎ Materials: Tube Body: Polypropylene (PP), Tube Cap: High-density polyethylene (HDPE), conforming to USP Class VI standards

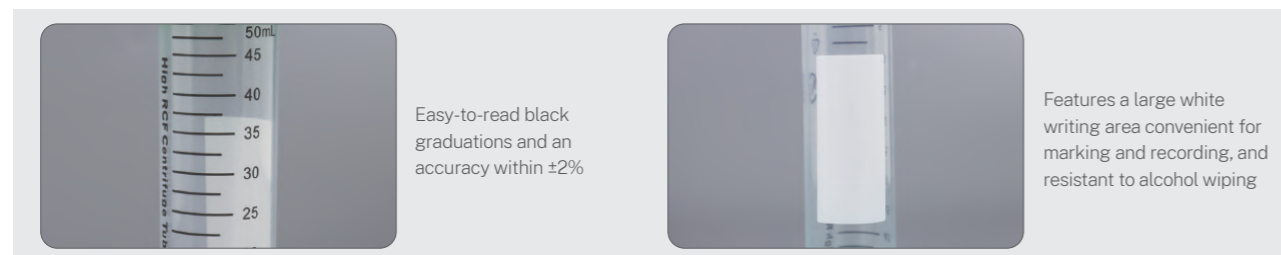

▲ Warning: 1. Do not use foam racks for cryopreservation (-80°C–20°C) of centrifuge tubes.
2. Loosen cap during autoclave sterilization.

Cat. No.	Capacity (mL)	Bottom	Sterile	Maximum RCF (×g)	Package	Qty. Per Bag	Qty. Per Case
CFT312150	15	Conical	Y	21,000	Re-sealable bag	25	500
CFT322150	15	Conical	Y	21,000	Paper rack	25	500
CFT312500	50	Conical	Y	21,000	Re-sealable bag	25	500
CFT322500	50	Conical	Y	21,000	Paper rack	25	500

15 ml Centrifuge Tubes with Puncture Hole

These products are made of high-quality transparent polymer polypropylene (PP); the cap features a butyl rubber stopper for connecting to a syringe.

- ◎ Specification: 15 mL
- ◎ Bottom Type: Conical
- ◎ Materials: Tube body: Polypropylene (PP), Tube cover: High-density polyethylene (HDPE), conforming to USP Class VI standards

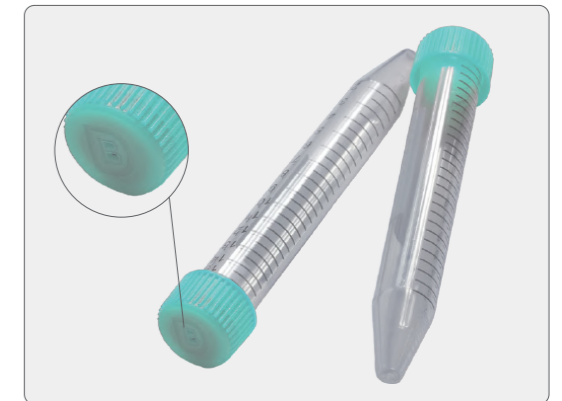

Cat. No.	Volume (mL)	Bottom	Sterile	Max Rotational Speed (×g)	Description	Package	Qty. Per Bag	Qty. Per Case
CFT013150-BD	15	Conical	Y	12500	Cap: 100/bag Tube: 25/bag	Re-sealable bag	Cap: 100 Tube: 25	Cap: 500 Tube: 500

Metal-Free Centrifuge Tubes

The metal-free centrifuge tubes are made of transparent polypropylene (PP). They have been specially treated to ensure that more than 30 kinds of trace metal elements that can interfere with experiments are kept at levels of less than 1ppb (ICP-MS method). They are ideal for a variety of environmental tests such as water analysis, and other applications where samples may be contaminated by heavy metals in centrifuge tubes.



- ◎ Specification: 15 mL 50 mL
- ◎ Cap Type: Flat
- ◎ Bottom Type: Conical
- ◎ Packaging: Re-sealable Bag Paper Rack Bulk
- ◎ Materials: Tube Body: Polypropylene (PP), Tube Cap: High-density polyethylene (HDPE), conforming to USP Class VI standards

Cat. No.	Capacity (mL)	Bottom	Sterile	Maximum RCF (×g)	Package	Qty. Per Bag (Rack, Bulk)	Qty. Per Case
CFT450150	15	Conical	Y	12,500	Re-sealable bag	25	500
CFT451150	15	Conical	Y	12,500	Paper rack	50	500
CFT452150	15	Conical	Y	12,500	Bulk	500	500
CFT450500	50	Conical	Y	12,500	Re-sealable bag	25	500
CFT451500	50	Conical	Y	12,500	Paper rack	25	500
CFT452500	50	Conical	Y	12,500	Bulk	500	500

EasyFlip™ Centrifuge Tubes

These products are primarily used for the storage, operation and centrifugation of mid-volume samples. The caps are easy to flip open and can be operated with one hand.

- Specification: 15 mL 50 mL
- Bottom Type: Conical bottom
- Packaging: Re-sealable Bag Paper Rack
- Materials: Tube Body: Polypropylene (PP), Tube Cap: High-density polyethylene (HDPE), conforming to USP Class VI standards



Cat. No.	Capacity (mL)	Bottom	Sterile	Maximum RCF (×g)	Package	Qty. Per Bag(Rack, Bulk)	Qty. Per Case
CFT201150	15	Conical	N	9,400	Bulk	500	500
CFT211150	15	Conical	Y	9,400	Re-sealable bag	25	500
CFT221150	15	Conical	Y	9,400	Paper rack	50	500
CFT212150	15	Conical	Y	9,400	Re-sealable bag	25	500
CFT222150	15	Conical	Y	9,400	Paper rack	50	500
CFT201500	50	Conical	N	9,400	Bulk	500	500
CFT211500	50	Conical	Y	9,400	Re-sealable bag	25	500
CFT221500	50	Conical	Y	9,400	Paper rack	50	500
CFT212500	50	Conical	Y	9,400	Re-sealable bag	25	500
CFT222500	50	Conical	Y	9,400	Paper rack	25	500

30 mL Self-Standing Centrifuge Tubes

The 30 mL self-standing centrifuge tubes are suitable for storage, operation and centrifugation of mid-volume samples. The products have the same diameter as the 50 mL centrifuge tube, but with a lower height. This reduces the risk of sample contamination and fills the gap between traditional 15 mL and 50 mL centrifuge tubes.

- Specification: 30 mL
- Cap Type: Flat
- Bottom Type: Self-standing
- Packaging: Re-sealable Bag
- Materials: Tube Body: Polypropylene (PP), Tube Cap: High-density polyethylene (HDPE), conforming to USP Class VI standards

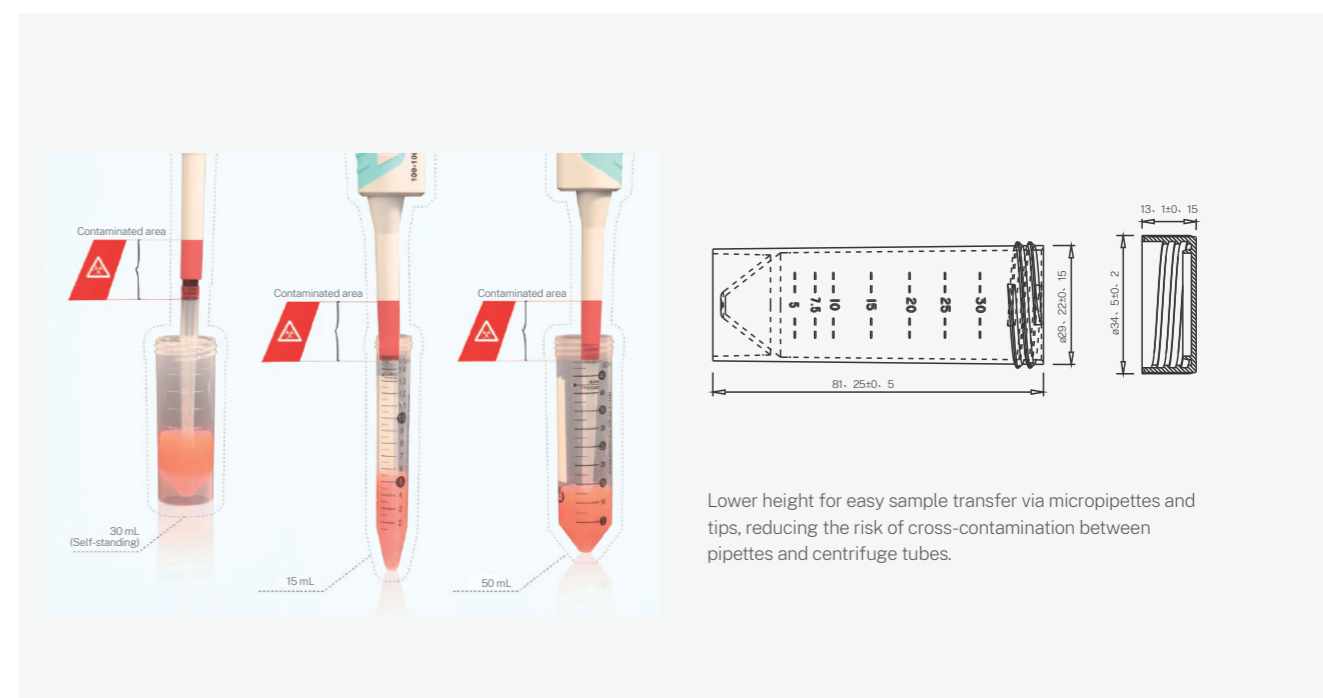

Lower height for easy sample transfer via micropipettes and tips, reducing the risk of cross-contamination between pipettes and centrifuge tubes.

Cat. No.	Capacity (mL)	Bottom	Sterile	Maximum RCF (×g)	Package	Qty. Per Bag	Qty. Per Case
CFT001030	30	Self-standing	Y	7,500	Re-sealable bag	50	500
CFT011030	30	Self-standing	N	7,500	Re-sealable bag	50	500
CFT000030	30	Self-standing	N	7,500	Re-sealable bag	500	500

Plastic Centrifuge Tube Racks

Plastic centrifuge tube racks help save laboratory space and are convenient to use. These products are an ideal tool for the handling and long-term (or short-term) storage of samples.

- ◎ Specification: 15 mL 50 mL
- ◎ Materials: Polypropylene (PP), conforming to USP Class VI standards



Features

- ◎ Suitable for 15 mL and 50 mL centrifuge tubes; surface with markings easy to identify and convenient for experimental recording
- ◎ Stackable to save space
- ◎ Working temperature range: -80°C -121°C
- ◎ Can be cleaned for re-use
- ◎ Sterilized and non-sterilized available, sterilized by irradiation to SAL 10⁻⁶
- ◎ DNase/RNase-free, non-pyrogenic

Cat. No.	Volume (mL)	Sterile	Color	Package	Qty. Per Bag	Qty. Per Case
CFR001015	15	N	Light green	Re-sealable bag	5	50
CFR011015	15	Y	Light green	Re-sealable bag	5	50
CFR002015	15	N	Dark green	Re-sealable bag	5	50
CFR012015	15	Y	Dark green	Re-sealable bag	5	50
CFR003015	15	N	White	Re-sealable bag	5	50
CFR013015	15	Y	White	Re-sealable bag	5	50
CFR004015	15	N	Blue	Re-sealable bag	5	50
CFR014015	15	Y	Blue	Re-sealable bag	5	50
CFR001050	50	N	Light green	Re-sealable bag	5	50
CFR011050	50	Y	Light green	Re-sealable bag	5	50
CFR002050	50	N	Dark green	Re-sealable bag	5	50
CFR012050	50	Y	Dark green	Re-sealable bag	5	50
CFR003050	50	N	White	Re-sealable bag	5	50
CFR013050	50	Y	White	Re-sealable bag	5	50
CFR004050	50	N	Blue	Re-sealable bag	5	50
CFR014050	50	Y	Blue	Re-sealable bag	5	50

Centrifuge Tube Stands

The centrifuge tube stands are suitable for 2.0 mL, 15 mL and 50 mL conical-bottom centrifuge tubes. They can be used in combination with conical centrifuge tubes in the laboratory.

- ◎ Materials: Polypropylene (PP), conforming to USP Class VI standards



Features

- ◎ The holes are designed for both 2.0 mL standard micro centrifuge tubes and 15 mL and 50 mL conical centrifuge tubes.
- ◎ The multi-hole design of the tube stand allows for accommodation of three 2.0 mL micro centrifuge tubes, three 15 mL centrifuge tubes and one 50 mL centrifuge tube.
- ◎ Can be cleaned for re-use
- ◎ The product is designed in the shape of a round table, making it extremely stable
- ◎ Working temperature range: -80°C-121°C
- ◎ Sterilized and non-sterilized available, sterilized by irradiation to SAL 10⁻⁶
- ◎ DNase/RNase-free, non-pyrogenic

Cat. No.	Product Description	Sterile	Qty. Per Bag	Qty. Per Case
CTS001001	7 holes, suitable for 2.0 mL microcentrifuge tube and 15 mL, 50 mL conical centrifuge tubes	N	1	50
CTS002001		Y	1	50
CTS001002		N	5	50
CTS002002		Y	5	50

Serum & Sample Tubes

The serum & sample tubes are made of transparent polypropylene (PP), and have excellent chemical stability and air tightness, making them suitable for the preservation and cryopreservation of serum, cells and tissues.

- Specification: 0.5 mL 1.5 mL 2.0 mL 5.0 mL 15.0 mL 50.0 mL
- Bottom Type: Conical Self-standing
- Materials: Tube Body: Polypropylene (PP), Tube Cap: High-density polyethylene (HDPE), conforming to USP Class VI standards

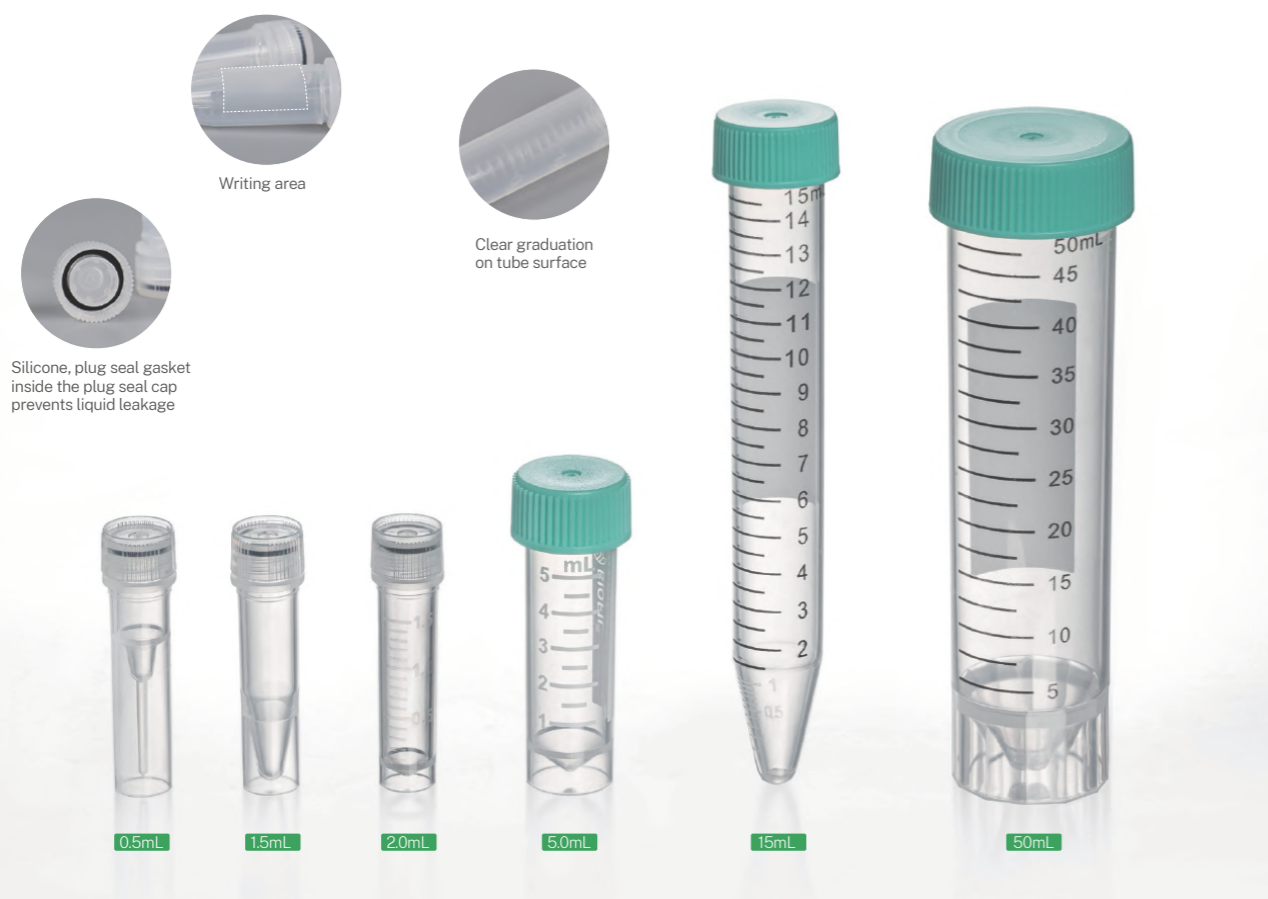

Features

- 6 specifications available: 0.5 mL, 1.5 mL, 2.0 mL, 5.0 mL, 15.0 mL, 50.0 mL
- The tube is made of PP— even transparent, and resistant to ultra-low temperature.
- The tube body is designed with writing area to facilitate recognition and labeling
- Silicone plug seal washer inside the plug seal cap prevents liquid leakage
- Sterilized and non-sterilized versions are available. Sterilized by irradiation, SAL 10⁻⁶
- DNase/RNase-free, non-pyrogenic

Cat. No.	Capacity (mL)	Bottom	Graduation Line	Sterile	Qty. Per Bag	Qty. Per Case
SST000005	0.5	Self-standing	Without	N	50	5000
SST001005	0.5	Self-standing	Without	Y	50	5000
SST001015	1.5	Self-standing	Without	Y	50	5000
SST000015	1.5	Self-standing	Without	N	50	5000
SST001020	2.0	Self-standing	With	Y	20	5000
SST000020	2.0	Self-standing	With	N	20	5000
SST001050	5.0	Self-standing	With	Y	20	2500
SST000050	5.0	Self-standing	With	N	20	2500
SST001150	15.0	Conical	With	Y	25	500
SST001500	15.0	Conical	With	N	50	500
SST001500	50.0	Self-standing	With	Y	25	500
SST000500	50.0	Self-standing	With	N	25	500

Plastic Pasteur Pipets

Plastic pasteur pipets are suitable for quick pipetting or transfer of liquids of non-fixed amounts.

- Specification: 145 mm 230 mm
- Packaging: Individual package (paper/plastic) Bulk
- Materials: Polystyrene (PS), conforming to USP Class VI standards



Features

- Two specifications are available: 145 mm and 230 mm
- Slender tube tip makes it easy to remove liquids from narrow-mouthed or small containers
- Transparent and scale-free for easy observation
- Sterilized by irradiation, SAL 10⁻⁶
- DNase/RNase-free, non-pyrogenic

Cat. No.	Length (mm)	Material	Sterile	Package	Qty. Per Bag(Bulk)	Qty. Per Case
PP000145	145	PS	Y	Individual	50	200
PP010145	145	PS	Y	Bulk	25	200
PP000230	230	PS	Y	Individual	50	200
PP010230	230	PS	Y	Bulk	25	200

Serological Pipets

Serological pipets are mainly used to measure or transfer a certain volume of liquid. When used with a suitable pipette, they have wide applications in the fields of cell culture, bacteriology, as well as clinical and scientific research. The JET BIOFIL serological pipets, in addition to having a pipet body with different precision graduations, feature pipet heads that are marked with the different capacities and different color codes for the ease of identification and use. The head of the pipet features a filter plug that prevents cross-contamination when aspirating samples, and the products are compatible with various common pipettes thanks to its optimized pipet head design.

- Specification: 1.0 mL 2.0 mL 5.0 mL 10.0 mL 25.0 mL 50.0 mL 100.0 mL
- Packaging: Individual Package (Paper/Plastic) Individual Package (Plastic/Plastic) Individual Package in Bag (Paper/Plastic) Individual Package in Bag (Plastic/Plastic) Bulk
- Materials: Pipet Body: Polystyrene (PS), Pipet Filter: Polyolefin (PO), conforming to USP Class VI standards

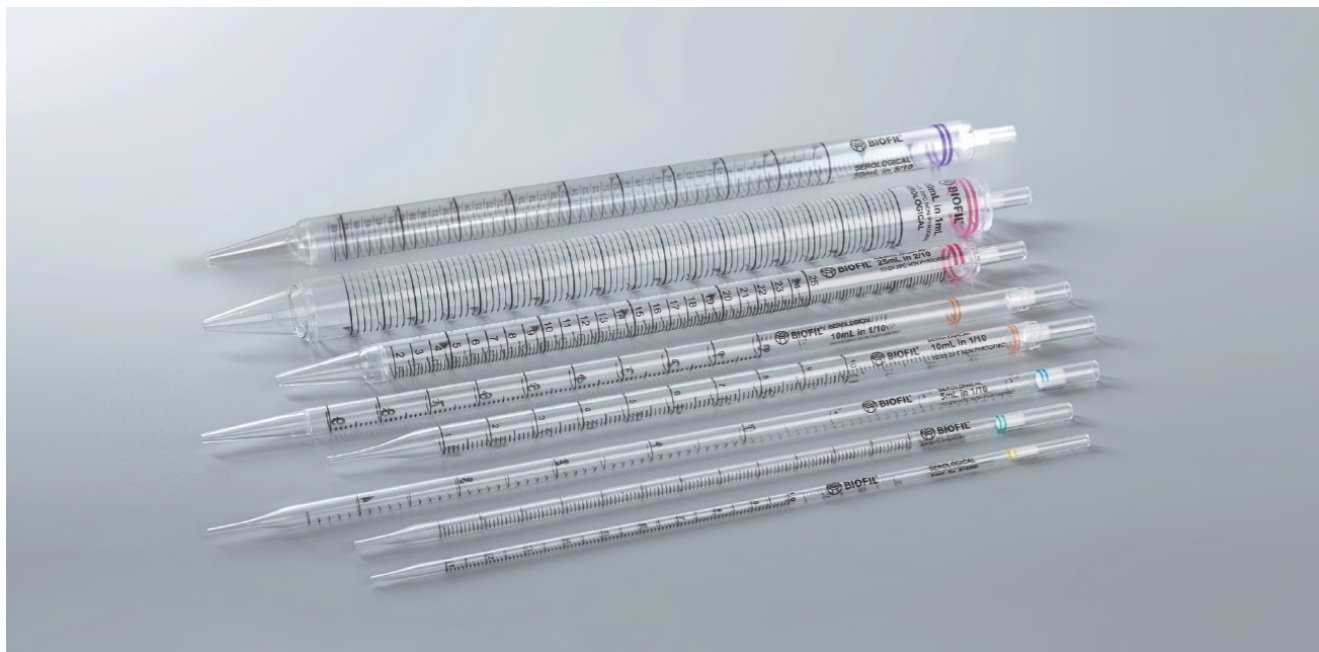

The pipet head is marked with different color codes, making the pipet range and model easy to identify



Designed with dual graduation markings, ensuring the pipet volume can be easily identified



Choice of ultrasonic welding or stretching



The filter element, made of PO, prevents aerosols or liquids from contaminating the pipetting device

Features

- Various capacities and specifications are available
- The pipet head is marked with different color codes for easy identification of the pipet range and model
- Designed with dual graduation to facilitate the identification of pipetting volumes. Negative graduations enhance pipet capacity and satisfy larger volume requirements
- The graduation is clear and precise, and has an accuracy of up to $\pm 2\%$ of the total volume
- Pipets of each specification are equipped with a filter element, which can prevent the sample, as well as any aerosol or water vapor, from entering the pipette; it also prevents impurities in the pipette from contaminating the sample, as well as cross-contamination
- The 1.0, 2.0, 5.0 and 10.0 mL pipets are stretched, while the 10.0, 25.0, 50.0 and 100 mL pipets are ultrasonically welded at the tip and mouth
- The optimized pipet head is compatible with most kinds of pipette with an adapter tip that are available on the market.
- A variety of packaging methods are available: paper-plastic or plastic-plastic, which can be torn or opened for easy operation; the bulk package is easy to use in batches and reduces packaging waste
- Individually blister packed in peel-to-open paper/plastic and plastic/plastic wrappers with printed lot No. for quality traceability
- Sterilized and non-sterilized available, sterilized by irradiation to SAL 10^{-6}
- DNase/RNase-free, non-pyrogenic

Bulk Vacuum Package

Cat. No.	Volume (mL)	Graduation (mL)	Length (mm)	Color Code	Sterile	Qty. Per Bulk	Qty. Per Case
GSP012001	1	1/100	268.5	Yellow	Y	25	1000
GSP012002	2	1/50	272.0	Green	Y	25	1000
GSP012005	5	1/10	341.0	Blue	Y	25	500
GSP012010	10	1/10	346.3	Orange	Y	25	400
GSP012110	10, Wide Mouth	1/10	346.3	Orange	Y	25	400
GSP112010	10, Stretch	1/10	303.4	Orange	Y	25	400
GSP121010	10, Stretch	1/10	303.4	Orange	Y	50	200
GSP012025	25	2/10	308.5	Red	Y	10	150
GSP012125	25, Long	2/10	338.9	Red	Y	10	150
GSP012050	50	5/10	346.6	Dark Blue	Y	10	100
GSP012100	100	1	346.8	Pink	Y	10	60
GSP011001	1	1/100	268.5	Yellow	N	25	1000
GSP011002	2	1/50	272.0	Green	N	25	1000
GSP011102	2	1/100	272.0	Green	N	25	1000
GSP011005	5	1/10	341.0	Blue	N	25	500
GSP011010	10	1/10	346.3	Orange	N	25	400
GSP011110	10, Wide Mouth	1/10	346.3	Orange	N	25	400
GSP111010	10, Stretch	1/10	303.4	Orange	N	25	400
GSP011025	25	2/10	308.5	Red	N	10	150
GSP011125	25, Long	2/10	338.9	Red	N	10	150
GSP011050	50	5/10	346.6	Dark Blue	N	10	100
GSP011100	100	1	346.8	Pink	N	10	60

Serological Pipets, Individually Packaged (Paper/Plastic)

Cat. No.	Volume (mL)	Graduation (mL)	Length (mm)	Color Code	Sterile	Qty. Per Bag	Qty. Per Case
GSP010001	1	1/100	268.5	Yellow	Y	1	500
GSP010002	2	1/50	272.0	Green	Y	1	500
GSP010102	2	1/100	272.0	Green	Y	1	500
GSP010005	5	1/10	341.0	Blue	Y	1	200
GSP010010	10	1/10	346.3	Orange	Y	1	200
GSP010110	10, Wide Mouth	1/10	346.3	Orange	Y	1	200
GSP210110	10, Stretch	1/10	303.4	Orange	Y	1	200
GSP010025	25	2/10	308.5	Red	Y	1	150
GSP010125	25, Long	2/10	338.9	Red	Y	1	150
GSP010050	50	5/10	346.6	Purple	Y	1	100
GSP010100	100	1	346.8	Pink	Y	1	50

Serological Pipets, Individually Packaged (Plastic/Plastic with internal sleeves)

Cat. No.	Volume (mL)	Graduation (mL)	Length (mm)	Color Code	Sterile	Qty. Per Bag	Qty. Per Case
GSP020001	1	1/100	268.5	Yellow	Y	1	500
GSP020002	2	1/50	272.0	Green	Y	1	500
GSP020102	2	1/100	272.0	Green	Y	1	500
GSP020005	5	1/10	341.0	Blue	Y	1	200
GSP010105	5, Wide Mouth	1/10	341.0	Blue	Y	1	200
GSP020010	10	1/10	346.3	Orange	Y	1	200
GSP020110	10, Wide Mouth	1/10	346.3	Orange	Y	1	200
GSP021010	10, Stretch	1/10	303.4	Orange	Y	1	200
GSP020025	25	2/10	308.5	Red	Y	1	150
GSP020125	25, Long	2/10	338.9	Red	Y	1	150
GSP020050	50	5/10	346.6	Purple	Y	1	100
GSP020100	100	1	346.8	Pink	Y	1	50

Serological Pipets, Individually Vacuum-packed in Bag (Paper/Plastic with internal sleeves)

Cat. No.	Volume (mL)	Graduation (mL)	Length (mm)	Color Code	Sterile	Qty. Per Bag	Qty. Per Case
GSP110001	1	1/100	268.5	Yellow	Y	100	600
GSP110002	2	1/50	272.0	Green	Y	100	500
GSP110102	2	1/100	272.0	Green	Y	100	500
GSP110005	5	1/10	341.0	Blue	Y	50	200
GSP110010	10	1/10	346.3	Orange	Y	50	200
GSP110110	10, Wide Mouth	1/10	346.3	Orange	Y	50	200
GSP210010	10, Stretch	1/10	303.4	Orange	Y	50	200
GSP110025	25	2/10	308.5	Red	Y	50	150
GSP110125	25, Long	2/10	338.9	Red	Y	50	150
GSP110050	50	5/10	346.6	Purple	Y	30	90
GSP110100	100	1	346.8	Pink	Y	10	50

Serological Pipets, Individually Vacuum-packed in Bag (Plastic/Plastic with internal sleeves)

Cat. No.	Volume (mL)	Graduation (mL)	Length (mm)	Color Code	Sterile	Qty. Per Bag	Qty. Per Case
GSP120001	1	1/100	268.5	Yellow	Y	100	600
GSP120002	2	1/50	272.0	Green	Y	100	500
GSP120102	2	1/100	272.0	Green	Y	100	500
GSP120005	5	1/10	341.0	Blue	Y	50	200
GSP120010	10	1/10	346.3	Orange	Y	50	200
GSP120110	10, Wide Mouth	1/10	303.4	Orange	Y	50	200
GSP120025	25	2/10	308.5	Red	Y	50	150
GSP120125	25, Long	2/10	338.9	Red	Y	50	150
GSP120050	50	5/10	346.6	Purple	Y	30	90
GSP120100	100	1	346.8	Pink	Y	10	50

Open End Pipets

The open end pipets are suitable for rapid suction of a certain volume of liquid during experiments, and are also able to suck up larger tissue blocks. They are widely used in the fields of tissue culture, and clinical and scientific research.

- Specifications: 1.0 mL 2.0 mL 5.0 mL 10.0 mL
- Packaging: Individual Package (Paper/Plastic) Individual Package in Bag (Plastic/Plastic) Bulk
- Materials: Pipet Body: Polystyrene (PS), Pipet Filter: Polyolefin (PO), conforming to USP Class VI standards

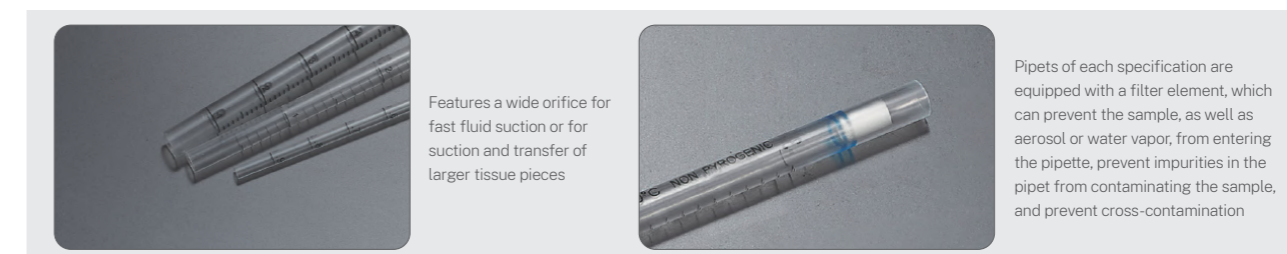

Serological Pipets Bulk Vacuum Package

Cat. No.	Volume (mL)	Graduation (mL)	Color Code	Material	Sterile	Package	Qty. Per Bag	Qty. Per Case
GSP312005	5	1/10	Blue	PS	Y	Paper/Plastic	25	500
GSP312010	10	1/10	Orange	PS	Y	Paper/Plastic	25	500

Serological Pipets, Individually Packaged (Paper/Plastic)

Cat. No.	Volume (mL)	Graduation (mL)	Color Code	Material	Sterile	Package	Qty. Per Bag	Qty. Per Case
GSP310001	1	1/100	Yellow	PS	Y	Paper/Plastic	500	500
GSP310002	2	1/100	Green	PS	Y	Paper/Plastic	500	500
GSP310005	5	1/10	Blue	PS	Y	Paper/Plastic	500	500
GSP310010	10	1/10	Orange	PS	Y	Paper/Plastic	200	200

Serological Pipets, Individually Vacuum-packed in Bag (Plastic/Plastic)

Cat. No.	Volume (mL)	Graduation (mL)	Color Code	Material	Sterile	Package	Qty. Per Bag	Qty. Per Case
GSP311005	5	1/10	Blue	PS	Y	Paper/Plastic	50	200
GSP311010	10	1/10	Orange	PS	Y	Paper/Plastic	50	200

Mini™ Serological Pipets

The Mini™ serological pipets are about half the length of a standard pipet, and is ergonomically designed for greater convenience when measuring and transferring liquids. They are especially suitable for liquid handling operations in limited and narrow spaces, such as laminar flow hoods.



- ◎ Specifications: 5.0 mL 10.0 mL 25.0 mL
- ◎ Packaging: Individual Package (Paper/Plastic)

- ◎ Materials: Pipet Body: Polystyrene (PS), Pipet Filter: Polyolefin (PO), conforming to USP Class VI standards

Cat. No.	Capacity (mL)	Graduation (mL)	Color Code	Sterile	Package	Qty. Per Pack	Qty. Per Case
GSP010205	5	1/10	■	Y	Paper/Plastic	1	200
GSP010210	10	2/10	■	Y	Paper/Plastic	1	150
GSP010225	25	5/10	■	Y	Paper/Plastic	1	100

Aspirating Pipets

The aspirating pipets are transparent and graduation-free, to facilitate observation during liquid suction. The filter-free design satisfies customer demands for continuous extraction of waste liquid.

- ◎ Specifications: 1.0 mL 2.0 mL 5.0 mL 10.0 mL 25.0 mL 50.0 mL 100.0 mL
- ◎ Packaging: Individual Package (Paper/Plastic) Individual Package (Plastic/Plastic) Bulk
- ◎ Materials: Polystyrene (PS), conforming to USP Class VI standards



Aspirating Pipets, Bulk Package

Cat. No.	Volume (mL)	Sterile	Qty. Per Bag	Qty. Per Case
GSP000001	1.0	Y	25	1000
GSP000002	2.0	Y	25	1000
GSP000005	5.0	Y	25	400
GSP000010	10.0	Y	25	400
GSP000025	25.0	Y	10	150
GSP000050	50.0	Y	10	100
GSP000100	100.0	Y	10	60
GSP001001	1.0	N	25	1000
GSP001002	2.0	N	25	1000
GSP001005	5.0	N	25	400
GSP001010	10.0	N	25	400
GSP001025	25.0	N	10	150
GSP001050	50.0	N	10	100
GSP001100	100.0	N	10	60

Aspirating Pipets, Individually Packaged (Plastic/Plastic), Stretch

Cat. No.	Volume (mL)	Sterile	Qty. Per Bag	Qty. Per Case
GSP002010	10.0	Y	25	400
GSP003010	10.0	N	25	400
GSP101010	10.0	Y	200	200
GSP201010	10.0	Y	50	200

Aspirating Pipets, Individually Packaged (Paper/Plastic)

Cat. No.	Volume (mL)	Sterile	Qty. Per Bag	Qty. Per Case
GSP100001	1.0	Y	1	500
GSP100002	2.0	Y	1	500
GSP100005	5.0	Y	1	200
GSP100010	10.0	Y	1	200
GSP100025	25.0	Y	1	150
GSP100050	50.0	Y	1	100
GSP100100	100.0	Y	1	50

Aspirating Pipets, Individually Packaged with interal sleeves (Paper/Plastic)

Cat. No.	Volume (mL)	Sterile	Qty. Per Bag	Qty. Per Case
GSP200001	1.0	Y	100	600
GSP200002	2.0	Y	100	500
GSP200005	5.0	Y	50	200
GSP200010	10.0	Y	50	200
GSP200025	25.0	Y	50	150
GSP200050	50.0	Y	30	90
GSP200100	100.0	Y	10	50

Milk Pipets

Suitable for the aspiration and transfer of micro-quantity liquids.

- ◎ Specification: 1.1 mL 2.2 mL
- ◎ Packaging: Individual Package (Paper/Plastic) Bulk
- ◎ Materials: Polystyrene (PS), conforming to USP Class VI standards



Milk Pipets, Individually Packaged (Paper/Plastic)

Cat. No.	Volume (mL)	Graduation (mL)	Color Code	Sterile	Package	Qty. Per Bag	Qty. Per Case
GSP010011	1.1	1/100	■	Y	Paper/Plastic	25	1000
GSP020011	1.1	1/50	■	Y	Paper/Plastic	50	500
GSP010022	2.2	1/10	■	Y	Paper/Plastic	50	400

Milk Pipets, Bulk Vacuum-packed

Cat. No.	Volume (mL)	Graduation (mL)	Color Code	Sterile	Package	Qty. Per Bag	Qty. Per Case
GSP011011	1.1	1/100	■	Y	Paper/Plastic	1000	1000
GSP021011	1.1	1/50	■	Y	Paper/Plastic	250	250
GSP011022	2.2	1/10	■	Y	Paper/Plastic	250	250

Disposable Sampling Tubes

Suitable for the collection, transportation and storage of samples. In addition to COVID-19 samples, they can also be used to preserve various virus samples such as those of influenza, avian influenza, HPV, and hand, foot and mouth disease.

- Materials: Tube Body: Polypropylene (PP), Tube Cap: High-density polyethylene (HDPE), conforming to USP Class VI standards

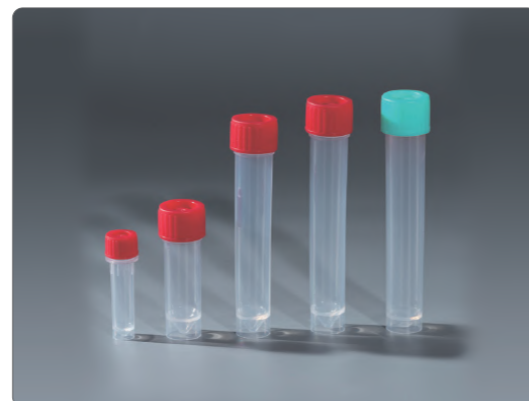

Features

- Conical bottom design facilitates easy pouring and reduces residue
- Spiral seal, manufactured with a unique structural design and process, prevents liquid leakage

Cat. No.	Volume (mL)	Bottom	Cap Color	Sterile	Tube Per Bag	Cap Per Bag
CYT001005	5.0	Self-standing	■	N	1000	1000
CYT001010	10.0	Self-standing	■	N	500	500
CYT001030	30.0	Self-standing	■	N	700	700
CYT002030	30.0	Self-standing	■	N	700	700

Transfer Pipets

Transfer pipets are often used in cell experiments, clinical experiments, cloning experiments and other operations for absorbing, transferring or carrying small amounts of liquid.

- Specifications: 0.2 mL 1.0 mL 3.0 mL
- Packaging: Single Packed Box Bulk
- Materials: Polyethylene (PE), conforming to USP Class VI standards

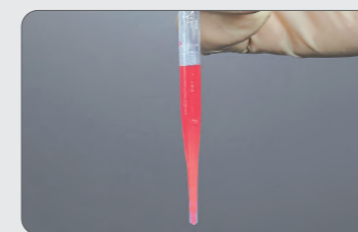
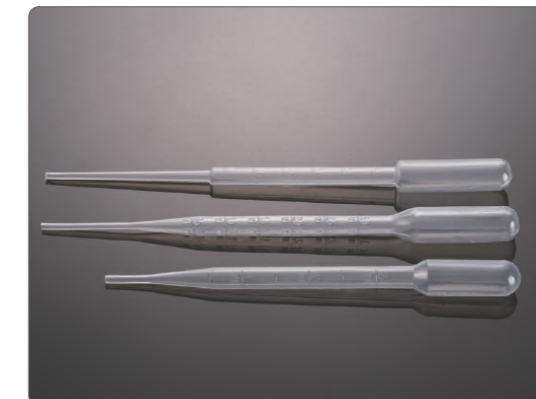

The orifice can be heat-sealed for easy carrying of liquids

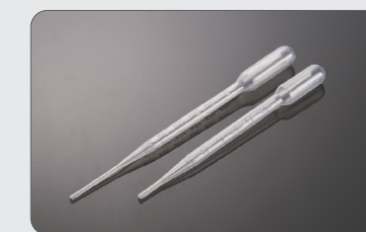

The pipet body is slender and flexible, and can be bent for easy access to micro-volume and special containers

Features

- Various capacities and specifications are available
- The pipet body is translucent and bright white with good fluid flow along the pipet wall, ensuring strong controllability
- Can be used in liquid nitrogen environments
- The pipet body is slender and flexible, and can be bent for easy access to micro-volume and special containers
- Small tip ensures repeatability of drop volume
- The pipet head can be heat-sealed for easy carrying of liquids
- Each pipet is printed with the lot No. for quality traceability
- Sterilized and non-sterilized available, sterilized by irradiation to SAL 10⁻⁶
- DNase/RNase-free, non-pyrogenic

Bulk Package

Cat. No.	Capacity (mL)	Length (mm)	Package	Sterile	Qty. Per Bag	Qty. Per Case
PP000002	0.2	68	Multiple	N	100	10000
PP000010	1.0	150	Multiple	N	100	5000
PP102010	1.0	150	Multiple	Y	20	4000
PP000030	3.0	155	Multiple	N	100	5000
PP003030	3.0	180	Multiple	N	100	5000
PP001002	0.2	68	Multiple	Y	100	10000
PP001010	1.0	150	Multiple	Y	100	5000
PP001030	3.0	155	Multiple	Y	100	5000
PP002030	3.0	180	Multiple	Y	100	5000

Individually Packaged

Cat. No.	Capacity (mL)	Length (mm)	Package	Sterile	Qty. Per Bag	Qty. Per Case
PP101002	0.2	68	Single	Y	1	5000
PP101010	1.0	150	Single	Y	1	4000
PP101030	3.0	155	Single	Y	1	4000
PP102030	3.0	180	Single	Y	1	4000

Individually Wrapped In Box

Cat. No.	Capacity (mL)	Length (mm)	Package	Sterile	Qty. Per Box	Qty. Per Case
PP201010	1.0	150	Single(Ful/Plastic)	Y	1	2000
PP205010	1.0	150	Single(Paper/Plastic)	Y	1	2000
PP200010	1.0	150	Multiple	N	200	2000
PP200030	3.0	155	Multiple	N	200	2000
PP201030	3.0	155	Single(Ful/Plastic)	Y	1	2000
PP205030	3.0	155	Single(Paper/Plastic)	Y	1	2000
PP202030	3.0	180	Single(Ful/Plastic)	Y	200	2000
PP203030	3.0	180	Single(Paper/Plastic)	Y	200	2000
PP303030	3.0	180	Multiple	N	200	2000

Square Media Bottles

The media bottles are made of high-transparency polyethylene terephthalate glycol (PETG), and are suitable for storing and transporting liquid culture medium, solution and serum.

- ◎ Specification: 30 mL 60 mL 125 mL 250 mL 500 mL 1000 mL
- ◎ Materials: Bottle Body: Polyethylene terephthalate glycol (PETG), Bottle Cap: High-density polyethylene (HDPE), conforming to USP Class VI standards

Features

- ◎ A square-shaped design, easy to hold and saves space
- ◎ Highly transparent with clear and accurate graduations
- ◎ Thick bottle wall, durable, fall-resistant, puncture resistant, resistant to strong pressure, and does not deform easily
- ◎ Good chemical resistance, which effectively prevents CO₂ and O₂ gas penetration and maintains PH stability
- ◎ Working temperature range: -80°C-60°C
- ◎ Sterilized by irradiation, SAL 10⁻⁶
- ◎ DNase/RNase-free, non-pyrogenic and non-cytotoxic



Cat. No.	Capacity (mL)	Characteristics	Sterile	Inner Diameter of Bottle Neck (mm)	Outer Diameter (mm)	Height with Cap (mm)	Qty. Per Tray	Qty. Per Case
SSB010030	30	With cap	Y	13.8	38.2 square	62.5	24	96
SSB010060	60	With cap	Y	18	40.4 square	82.5	24	96
SSB010125	125	With cap	Y	28.6	53 square	106.5	24	96
SSB010250	250	With cap	Y	28.6	59 square	144	24	96
SSB130500	500	With cap	Y	28.6	74 square	178.5	24	48
SSB010000	1000	With cap	Y	28.6	92 square	217	24	24

Solution Bottles

The solution bottles offered by JET BIOFIL are made of high-quality polymer polystyrene through a special production process. They are widely used for the storage and preparation of various liquid formulations in the laboratory, including culture solutions, serums, reagents, etc.

- ◎ Specification: 150 mL 250 mL 500 mL 1000 mL 2000 mL
- ◎ Materials: Bottle Body: Polystyrene (PS), Bottle Cap: High-density polyethylene (HDPE), conforming to USP Class VI standards



Features

- ◎ Excellent transparency and clear scale for easy volume observation
- ◎ Ergonomic design on both sides for easy holding
- ◎ Made of polystyrene for excellent transparency; solid structure and light weight
- ◎ Clear scale on bottle wall facilitates observation and recognition
- ◎ Wide-mouth design facilitates liquid pouring
- ◎ Resistant to weak acids and weak alkalis
- ◎ Each package bag is printed with the product lot No. for quality traceability
- ◎ Sterilized by irradiation, SAL 10⁻⁶
- ◎ DNase/RNase-free, non-pyrogenic

Cat. No.	Volume (mL)	Sterile	Qty. Per Bag	Qty. Per Case
CTF010150	150	Y	1	24
CTF010250	250	Y	1	24
CTF010500	500	Y	1	24
CTF010001	1000	Y	1	24
CTF010002	2000	Y	1	12



Stock code: 688026

Filtration

Membrane separation is considered one of the most promising high technologies from the end of the 20th century to the middle of the 21st century. Compared with other traditional separation methods, membrane separation is an economic, energy-saving and efficient technology with the advantages of a simple process, large separation coefficient, continuous operation at room temperature, direct amplification, and specificity of the membrane but without phase change and secondary contamination. With the continuous development of membrane separation technology, microfiltration, ultrafiltration and other membrane technologies have been widely used in biomedicine, biotechnology, energy engineering and other fields.

Microfiltration (MF)

Microfiltration, also known as microporous filtration, is a type of polishing filtration with a mechanism that is based on the sieving separation process. Microfiltration membranes are made of organic or inorganic materials. They are mainly used to remove particles, bacteria and other contaminants from the gas and liquid phases to achieve the purposes of purification, separation and concentration. Mycoplasma can be removed with 0.1 μm filters; most culture media, buffers, biofluids, and gases can be sterilized with 0.2 or 0.22 μm filters in routine laboratory tests; 0.45 μm filter membranes are preferred for the clarification and primary filtration of solutions and solvents. Filters produced by JET BIOFIL include syringe filters driven by positive pressure, vacuum bottle filters, etc., which can meet different demands for sterile filtration of culture media, buffers and reagents due to rich product forms and a variety of membrane materials.

Ultrafiltration (UF)

Ultrafiltration is a membrane separation technology with a pore size between that of microfiltration and nanofiltration. Ultrafiltration purifies, separates, and concentrates solutions based on the mechanism of the sieving process and is related to the membrane pore size ranging from 0.05 μm to 1 nm. The disposable centrifugal filters produced by JET BIOFIL are provided with polyethersulfone (PES) membranes with different molecular weight cutoffs (MWCs), which are characterized by low protein binding capacity and high throughput, and can be widely used for the concentration and desalination of biological samples, as well as buffer replacement.

Syringe Filters

Syringe filters, used with disposable syringes, are a fast, convenient and reliable filter processing device routinely used in laboratories for small-volume samples. They are mainly used in pre-filtration of samples, laboratory sterilization and filtration of biological fluids, media and media additives, sample preparation, and gas filtration. JET BIOFIL syringe filters are available in various sizes and membrane configurations for sterile and non-sterile laboratory operations.

- Diameter Specifications: 13 mm 25 mm 30 mm
- Membrane Pore Size: 0.1 μm 0.22 μm 0.45 μm
- Membrane Type: MCE Nylon PVDF PES PTFE CA SFCA PES Express
- Materials: Shell: Polypropylene (PP), conforming to USP Class VI standards



For use with disposable syringes

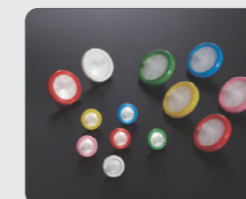

Different color outer rings correspond to different membrane types, and are easy to distinguish and identify

Features

- Single package and bulk packaging are available for different customer requirements
- Various membrane types and filtration diameters available
- Female Luer connector inlet and male Luer connector outlet
- Polypropylene shell comes with a color ring to distinguish filters of different materials
- 100% integrity test
- Sterilized and non-sterilized available, sterilized by irradiation to SAL 10^{-6}
- DNase/RNase-free, non-pyrogenic

Syringe Filters, Sterile, Individually Packed

Cat. No.	Membrane Material	Color	Pore Size (µm)	Housing Diameter (mm)	Sterile	Qty. Per Box	Qty. Per Case
FMC201013	MCE	○	0.22	13.0	Y	100	800
FMC201025		○	0.22	25.0	Y	45	360
FMC201030		○	0.22	30.0	Y	45	360
FMC401013		○	0.45	13.0	Y	100	800
FMC401025		○	0.45	25.0	Y	45	360
FMC401030		○	0.45	30.0	Y	45	360
FPV103013	PVDF	○	0.10	13.0	Y	100	800
FPV103025		○	0.10	25.0	Y	45	360
FPV103030		○	0.10	30.0	Y	45	360
FPV203013		○	0.22	13.0	Y	100	800
FPV203025		○	0.22	25.0	Y	45	360
FPV203030		○	0.22	30.0	Y	45	360
FPV403013		○	0.45	13.0	Y	100	800
FPV403025		○	0.45	25.0	Y	45	360
FPV403030		○	0.45	30.0	Y	45	360
PTF205013	PTFE	White	0.22	13.0	Y	100	800
PTF205025		White	0.22	25.0	Y	45	360
PTF205030		White	0.22	30.0	Y	45	360
PTF405013		White	0.45	13.0	Y	100	800
PTF405025		White	0.45	25.0	Y	45	360
PTF405030		White	0.45	30.0	Y	45	360
FNY202013	NYLON	○	0.22	13.0	Y	100	800
FNY202025		○	0.22	25.0	Y	45	360
FNY202030		○	0.22	30.0	Y	45	360
FNY402013		○	0.45	13.0	Y	100	800
FNY402025		○	0.45	25.0	Y	45	360
FNY402030		○	0.45	30.0	Y	45	360
FPE204013	PES	○	0.22	13.0	Y	100	800
FPE204025		○	0.22	25.0	Y	45	360
FPE204030		○	0.22	30.0	Y	45	360
FPE404013		○	0.45	13.0	Y	100	800
FPE404025		○	0.45	25.0	Y	45	360
FPE404030		○	0.45	30.0	Y	45	360
FCA206013	CA	○	0.22	13.0	Y	100	800
FCA206025		○	0.22	25.0	Y	45	360
FCA206030		○	0.22	30.0	Y	45	360
FCA406013		○	0.45	13.0	Y	100	800
FCA406025		○	0.45	25.0	Y	45	360
FCA406030		○	0.45	30.0	Y	45	360

Cat. No.	Membrane Material	Color	Pore Size (µm)	Housing Diameter (mm)	Sterile	Qty. Per Box	Qty. Per Case
SCA207013	SFCA	○	0.22	13.0	Y	100	800
SCA207025		○	0.22	25.0	Y	45	360
SCA207030		○	0.22	30.0	Y	45	360
SCA407013		○	0.45	13.0	Y	100	800
SCA407025		○	0.45	25.0	Y	45	360
SCA407030		○	0.45	30.0	Y	45	360
FPE204113	PES Express	○	0.22	13.0	Y	100	800
FPE204125		○	0.22	25.0	Y	45	360
FPE204130		○	0.22	30.0	Y	45	360
FPE404113		○	0.45	13.0	Y	100	800
FPE404125		○	0.45	25.0	Y	45	360
FPE404130		○	0.45	30.0	Y	45	360
GFA201025	GF1.1µm+CA0.22µm	Natural	0.22	25.0	Y	45	360
GFA201030		Natural	0.22	30.0	Y	45	360
GFA401025		Natural	0.45	25.0	Y	45	360
GFA401030		Natural	0.45	30.0	Y	45	360

Syringe Filters, Sterile, Bulk Packed

Cat. No.	Membrane Material	Color	Pore Size (µm)	Housing Diameter (mm)	Sterile	Qty. Per Box	Qty. Per Case
FMC211013	MCE	○	0.22	13.0	Y	100	1000
FMC211025		○	0.22	25.0	Y	50	500
FMC211030		○	0.22	30.0	Y	50	500
FMC411013		○	0.45	13.0	Y	100	1000
FMC411025		○	0.45	25.0	Y	50	500
FMC411030		○	0.45	30.0	Y	50	500
FPV113013	PVDF	○	0.10	13.0	Y	100	1000
FPV113025		○	0.10	25.0	Y	50	500
FPV113030		○	0.10	30.0	Y	50	500
FPV213013		○	0.22	13.0	Y	100	1000
FPV213025		○	0.22	25.0	Y	50	500
FPV213030		○	0.22	30.0	Y	50	500
FPV413013		○	0.45	13.0	Y	100	1000
FPV413025		○	0.45	25.0	Y	50	500
FPV413030		○	0.45	30.0	Y	50	500
PTF215013	PTFE	White	0.22	13.0	Y	100	1000
PTF215025		White	0.22	25.0	Y	50	500
PTF215030		White	0.22	30.0	Y	50	500
PTF415013		White	0.45	13.0	Y	100	1000
PTF415025		White	0.45	25.0	Y	50	500
PTF415030		White	0.45	30.0	Y	50	500
FNY212013	NYLON	○	0.22	13.0	Y	100	1000
FNY212025		○	0.22	25.0	Y	50	500
FNY212030		○	0.22	30.0	Y	50	500
FNY412013		○	0.45	13.0	Y	100	1000
FNY412025		○	0.45	25.0	Y	50	500
FNY412030		○	0.45	30.0	Y	50	500

Cat. No.	Membrane Material	Color	Pore Size (µm)	Housing Diameter (mm)	Sterile	Qty. Per Box	Qty. Per Case
FPE214013	PES	○	0.22	13.0	Y	100	1000
FPE214025		○	0.22	25.0	Y	50	500
FPE214030		○	0.22	30.0	Y	50	500
FPE414013		○	0.45	13.0	Y	100	1000
FPE414025		○	0.45	25.0	Y	50	500
FPE414030		○	0.45	30.0	Y	50	500
FCA216013	CA	○	0.22	13.0	Y	100	1000
FCA216025		○	0.22	25.0	Y	50	500
FCA216030		○	0.22	30.0	Y	50	500
FCA416013		○	0.45	13.0	Y	100	1000
FCA416025		○	0.45	25.0	Y	50	500
FCA416030		○	0.45	30.0	Y	50	500
SCA217013	SFCA	○	0.22	13.0	Y	100	1000
SCA217025		○	0.22	25.0	Y	50	500
SCA217030		○	0.22	30.0	Y	50	500
SCA417013		○	0.45	13.0	Y	100	1000
SCA417025		○	0.45	25.0	Y	50	500
SCA417030		○	0.45	30.0	Y	50	500

Syringe Filters, Non-Sterile, Bulk Packed

Cat. No.	Membrane Material	Color	Pore Size (µm)	Housing Diameter (mm)	Sterile	Qty. Per Box	Qty. Per Case
FMC221013	MCE	○	0.22	13.0	N	100	1000
FMC221025		○	0.22	25.0	N	50	500
FMC221030		○	0.22	30.0	N	50	500
FMC421013		○	0.45	13.0	N	100	1000
FMC421025		○	0.45	25.0	N	50	500
FMC421030		○	0.45	30.0	N	50	500
FPV123013	PVDF	○	0.10	13.0	N	100	1000
FPV123025		○	0.10	25.0	N	50	500
FPV123030		○	0.10	30.0	N	50	500
FPV223013		○	0.22	13.0	N	100	1000
FPV223025		○	0.22	25.0	N	50	500
FPV223030		○	0.22	30.0	N	50	500
FPV423013	PTFE	○	0.45	13.0	N	100	1000
FPV423025		○	0.45	25.0	N	50	500
FPV423030		○	0.45	30.0	N	50	500
PTF225013		White	0.22	13.0	N	100	1000
PTF225025		White	0.22	25.0	N	50	500
PTF225030		White	0.22	30.0	N	50	500
PTF425013	NYLON	White	0.45	13.0	N	100	1000
PTF425025		White	0.45	25.0	N	50	500
PTF425030		White	0.45	30.0	N	50	500
FNY222013		○	0.22	13.0	N	100	1000
FNY222025		○	0.22	25.0	N	50	500
FNY222030		○	0.22	30.0	N	50	500
FNY422013	PES	○	0.45	13.0	N	100	1000
FNY422025		○	0.45	25.0	N	50	500
FNY422030		○	0.45	30.0	N	50	500
FPE224013		○	0.22	13.0	N	100	1000
FPE224025		○	0.22	25.0	N	50	500
FPE224030		○	0.22	30.0	N	50	500
FPE424013	PES	○	0.45	13.0	N	100	1000
FPE424025		○	0.45	25.0	N	50	500
FPE424030		○	0.45	30.0	N	50	500

Cat. No.	Membrane Material	Color	Pore Size (µm)	Housing Diameter (mm)	Sterile	Qty. Per Box	Qty. Per Case
FCA226013	CA	○	0.22	13.0	N	100	1000
FCA226025		○	0.22	25.0	N	50	500
FCA226030		○	0.22	30.0	N	50	500
FCA426013		○	0.45	13.0	N	100	1000
FCA426025		○	0.45	25.0	N	50	500
FCA426030		○	0.45	30.0	N	50	500
SCA227013	SFCA	○	0.22	13.0	N	100	1000
SCA227025		○	0.22	25.0	N	50	500
SCA227030		○	0.22	30.0	N	50	500
SCA427013		○	0.45	13.0	N	100	1000
SCA427025		○	0.45	25.0	N	50	500
SCA427030		○	0.45	30.0	N	50	500
PTF225050	PTFE	Natural	0.22	50.0	N	1	150
PTF235050		Natural	0.45	50.0	N	1	150
PTF245050		Natural	0.22	50.0	N	1	150
PTF255050		Natural	0.45	50.0	N	1	150
PTF425050		Natural	0.45	50.0	N	10	200
PTF435050		Natural	0.45	50.0	N	10	200

50 mm Syringe Filters

The 50 mm syringe filter's shell is made of polypropylene (PP) and the filter membrane is made of polytetrafluoroethylene (PTFE). The syringe filter is surfactant-free and has a bi-directional filter membrane support combines a single/double stepped barb inlet/outlet for secure syringe loading. The product can be used to filter corrosive chemicals and solvents such as those used in GC and HPLC, as well as for sterile air or CO₂ gas filtration and to protect instruments from aqueous solutions.



- Membrane Pore Size: 0.22 µm 0.45 µm
- Pattern: One stepped barb Two stepped barbs
- Materials: Shell: Polypropylene (PP), Filter Membrane: Polytetrafluoroethylene (PTFE), conforming to USP Class VI standards

Features

- Membrane type and pore size are printed on each filter for easy product traceability
- Filter sample volume: 0.2 L–5.0 L
- The products are suitable for filtering gases and are also ideal for filtering corrosive chemicals and solvents
- DNase/RNase-free, non-pyrogenic

Individually Packaged

Cat. No.	Connectors	Pore Size (µm)	Housing Diameter (mm)	Sterile	Qty. Per Bag	Qty. Per Case
PTF245050	Hose Barb/Thread	0.22	50.0	N	1	150
PTF445050		0.45	50.0	N	1	150
PTF255050	Hose Barb/Hose Barb	0.22	50.0	N	1	150
PTF455050		0.45	50.0	N	1	150

Rack Box

Cat. No.	Connectors	Pore Size (µm)	Housing Diameter (mm)	Sterile	Qty. Per Bag	Qty. Per Case
PTF225050	Hose Barb Thread	0.22	50.0	N	10	200
PTF425050		0.45	50.0	N	10	200
PTF235050	Hose Barb Hose Barb	0.22	50.0	N	20	240
PTF435050		0.45	50.0	N	20	240

50 mm Sterilizing Filter

Positive pressure sterilizing filters are widely applicable to sterilizing filtration of aqueous solutions in biological laboratories, and can be used with a peristaltic pump, syringe or other positive pressure device.

JET BIOFIL's 50 mm sterilizing filter is suitable for removing microorganisms, particles, precipitates, and undissolved powders larger than 0.22 µm from aqueous solutions. This product has the stepped hose barb design that ensures stable connection between the filter and the hose. This product is made of 0.22 µm hydrophilic polyethersulfone (PES) membrane and can filter samples up to 8 L in volume. Its excellent filtration performance and reliable sterilization capability provide an efficient solution for the sterilizing filtration of liquids in biological laboratories.



- Membrane diameter: 50 mm
- Membrane pore size: 0.22 µm
- Pattern: Two stepped barbs, filling bell
- Materials:
 - Filter housing: Methyl methacrylate-butadiene-styrene (MBS)
 - Filter Membrane: Hydrophilic polyethersulfone (PES)
 - Filling Bell: Polycarbonate (PC)
 - Filling Bell Cap: Low-density polyethylene (LDPE)
 - Conforming to USP Class VI standards

Features

- The filter membrane is made of 0.22 µm hydrophilic polyethersulfone for high throughput and excellent filtration performance
- The products have an effective filtration area of up to 19.9 cm², and can filter samples up to 3.8-8 L in volume
- Maximum operating temperature: 45°C
- Maximum inlet pressure: 3.3 bars (50 psi) at 25°C
- Typical water flow rate: 390 mL/min at 25°C under 15 psi
- It is designed with a filling bell avoiding liquid splashing and pollution
- Stepped hose barb design that ensures stable connection between the filter and the hose
- Filter surface with coding marks, clearly distinguish inlet and outlet
- Sterilized by irradiation, SAL 10⁻⁶, DNase/RNase-free, Non-pyrogenic, Non-cytotoxic

Special Tips:

The test results show that the 50 mm sterilizing filters are suitable for most aqueous solutions, such as acetic acid (5%), aqueous buffer, cell media, Clorox® bleaching agent (5% solution), sodium hydroxide (10%), sulfuric acid (20%). The unlisted reagents should be tested for applicability before use.

Cat. No.	Description	Adaptive Tube Diameter	Membrane Pore Size (µm)	Membrane Diameter (mm)	Outer Diameter (mm)	Sterile	Qty. Per Bag	Qty. Per Case
FPE305050	PES membrane, two stepped barbs, filling bell	1/2 "-1/4 "ID	0.22	50	62	Y	1	10
FPE315050	PES membrane, two stepped barbs, without filling bell	1/2 "-1/4 "ID	0.22	50	62	Y	1	10

Before using this product, please read this Manual carefully and operate according to the instructions.

Vacuum Bottle Filters

The vacuum bottle filters provide a pressure differential through a vacuum pump, and are used for large-scale filtration of tissue culture fluids and other laboratory solutions. The sample processing volume can be up to several liters, while the filtered sample can be directly stored in a sterile collection bottle. These products are ideal for sterile filtration of culture media, buffers and reagents. A complete vacuum filter set is composed of an upper cup cover, an upper cup, a connector, a filter membrane and a reservoir bottle.

- Membrane Pore Size: 0.10 µm 0.22 µm 0.45 µm
- Membrane Type: MCE Nylon PVDF CA SFCA PES PES Express
- Upper Cup Capacity: 150 mL 250 mL 500 mL 1000 mL
- Reservoir Bottle Capacity: 150 mL 250 mL 500 mL 1000 mL
- Materials: Upper Filter Cup and Reservoir Bottle: Polystyrene (PS), Green Connector: Acrylonitrile-butadiene-styrene copolymer (ABS), White Connector: Polypropylene (PP), conforming to USP Class VI standards







Sloped hose fittings make it easier to connect to vacuum pipelines.



The product is vacuum packed and sterilized by irradiation



The easy-grip design on both sides of the reservoir bottle is ergonomic and easy to hold



A variety of membrane materials and specifications (150 mL, 250 mL, 500 mL, 1000 mL) are available to meet a variety of experimental requirements

Features

- A variety of membrane materials and specifications are available to satisfy different demands for customer applications
- Sloped hose fittings make it easier to connect vacuum pipelines
- The upper cup has a GL-45 thread and fits most glass and plastic media storage bottles
- The easy-grip design on both sides of the reservoir bottle is ergonomic and makes the bottle easy to hold
- Good transparency, clear scale, easy to observe capacity
- PES express has faster filtration and lower clogging rate
- Each bag is printed with the product lot No. for quality traceability
- Sterilized by irradiation, SAL 10⁻⁶
- DNase/RNase-free, non-pyrogenic

Cat. No.	Membrane Material	Pore Size (µm)	Capacity (mL)	Membrane Diameter (mm)	Qty. Per Bag	Qty. Per Case	
FPV103150	PVDF	0.10	150	φ50	1	12	
FPV103250		0.10	250	φ50	1	12	
FPV103500		0.10	500	φ75	1	12	
FPV103000		0.10	1000	φ91	1	12	
FPV203150		0.22	150	φ50	1	12	
FPV203250		0.22	250	φ50	1	12	
FPV203500		0.22	500	φ75	1	12	
FPV203000		0.22	1000	φ91	1	12	
FPV403150		0.45	150	φ50	1	12	
FPV403250		0.45	250	φ50	1	12	
FPV403500		0.45	500	φ75	1	12	
FPV403000		0.45	1000	φ91	1	12	
FMC201150		MCE	0.22	150	φ50	1	12
FMC201250			0.22	250	φ50	1	12
FMC201500			0.22	500	φ75	1	12
FMC201000	0.22		1000	φ91	1	12	
FMC401150	0.45		150	φ50	1	12	
FMC401250	0.45		250	φ50	1	12	

Cat. No.	Membrane Material	Pore Size (µm)	Capacity (mL)	Membrane Diameter (mm)	Qty. Per Bag	Qty. Per Case	
FMC401500	MCE	0.45	500	φ75	1	12	
FMC401000		0.45	1000	φ91	1	12	
FPE204150	PES	0.22	150	φ50	1	12	
FPE204250		0.22	250	φ50	1	12	
FPE204500		0.22	500	φ75	1	12	
FPE204000		0.22	1000	φ91	1	12	
FPE404150		0.45	150	φ50	1	12	
FPE404250		0.45	250	φ50	1	12	
FPE404500		0.45	500	φ75	1	12	
FPE404000		0.45	1000	φ91	1	12	
FNY202150	Nylon	0.22	150	φ50	1	12	
FNY202250		0.22	250	φ50	1	12	
FNY202500		0.22	500	φ75	1	12	
FNY202000		0.22	1000	φ91	1	12	
FNY402150		0.45	150	φ50	1	12	
FNY402250		0.45	250	φ50	1	12	
FNY402500		0.45	500	φ75	1	12	
FNY402000		0.45	1000	φ91	1	12	
FCA206150		CA	0.22	150	φ50	1	12
FCA206250			0.22	250	φ50	1	12
FCA206500	0.22		500	φ75	1	12	
FCA206000	0.22		1000	φ91	1	12	
FCA406150	0.45		150	φ50	1	12	
FCA406250	0.45		250	φ50	1	12	
FCA406500	0.45		500	φ75	1	12	
FCA406000	0.45		1000	φ91	1	12	
FPE234150	PES Express	0.22	150	φ50	1	12	
FPE234250		0.22	250	φ50	1	12	
FPE234500		0.22	500	φ75	1	12	
FPE234000		0.22	1000	φ91	1	12	
FPE434150		0.45	150	φ50	1	12	
FPE434250		0.45	250	φ50	1	12	
FPE434500		0.45	500	φ75	1	12	
FPE434000		0.45	1000	φ91	1	12	
SCA207150		SFCA	0.22	150	φ50	1	12
SCA207250			0.22	250	φ50	1	12
SCA207500	0.22		500	φ75	1	12	
SCA207000	0.22		1000	φ91	1	12	

Cat. No.	Membrane Material	Pore Size (µm)	Capacity (mL)	Membrane Diameter (mm)	Qty. Per Bag	Qty. Per Case
SCA407250	SFCA	0.45	250	φ50	1	12
SCA407150		0.45	150	φ50	1	12
SCA407500		0.45	500	φ75	1	12
SCA407000		0.45	1000	φ91	1	12

Filter Upper Cups

The system uses a vacuum pump to provide differential pressure to filter tissue culture fluids and other laboratory solutions. The filtrate can be directly stored in a sterile collection bottle, significantly shortening the pipetting process and improving efficiency. The Filter Upper Cup includes an upper cup cover, an upper cup, and a connector.



- Membrane pore size: 0.10 µm 0.22 µm 0.45 µm
- Membrane type: MCE Nylon PVDF CA SFCA PES PES express
- Upper cup capacity: 150 mL 250 mL 500 mL 1000 mL
- Materials: Upper filter cup: Polystyrene (PS), Green connector: Acrylonitrile-butadiene-styrene copolymer (ABS), White connector: Polypropylene (PP), conforming to USP Class VI standards

Features

- Offering a variety of membrane materials and numerous specifications to meet different experimental needs
- The inclined hose connector makes it easier to connect to the vacuum pipeline
- The upper cup is equipped with a GL-45 thread, suitable for most glass and plastic culture medium storage bottles
- Good transparency with clear graduation lines for easy volume observation
- Sterilized by irradiation, SAL 10⁻⁶
- DNase/RNase-free, non-pyrogenic

Cat. No.	Membrane Material	Pore Size (µm)	Capacity (mL)	Diameter (mm)	Qty. Per Bag	Qty. Per Case
FPV113150	PVDF	0.10	150	φ50	1	24
FPV113250		0.10	250	φ50	1	24
FPV113500		0.10	500	φ75	1	24
FPV113000		0.10	1000	φ91	1	24
FPV213150		0.22	150	φ50	1	24
FPV213250		0.22	250	φ50	1	24

Cat. No.	Membrane Material	Pore Size (µm)	Capacity (mL)	Membrane Diameter (mm)	Qty. Per Bag	Qty. Per Case
FPV213500	PVDF	0.22	500	φ75	1	24
FPV213000		0.22	1000	φ91	1	24
FPV413150		0.45	150	φ50	1	24
FPV413250		0.45	250	φ50	1	24
FPV413500		0.45	500	φ75	1	24
FPV413000		0.45	1000	φ91	1	24
FMC211150	MCE	0.22	150	φ50	1	24
FMC211250		0.22	250	φ50	1	24
FMC211500		0.22	500	φ75	1	24
FMC211000		0.22	1000	φ91	1	24
FMC411150		0.45	150	φ50	1	24
FMC411250		0.45	250	φ50	1	24
FMC411500	0.45	500	φ75	1	24	
FMC411000	0.45	1000	φ91	1	24	
FPE214150	PES	0.22	150	φ50	1	24
FPE214250		0.22	250	φ50	1	24
FPE214500		0.22	500	φ75	1	24
FPE214000		0.22	1000	φ91	1	24
FPE414150		0.45	150	φ50	1	24
FPE414250		0.45	250	φ50	1	24
FPE414500	0.45	500	φ75	1	24	
FPE414000	0.45	1000	φ91	1	24	
FNY212150	Nylon	0.22	150	φ50	1	24
FNY212250		0.22	250	φ50	1	24
FNY212500		0.22	500	φ75	1	24
FNY212000		0.22	1000	φ91	1	24
FNY412150		0.45	150	φ50	1	24
FNY412250		0.45	250	φ50	1	24
FNY412500	0.45	500	φ75	1	24	
FNY412000	0.45	1000	φ91	1	24	
FCA216150	CA	0.22	150	φ50	1	24
FCA216250		0.22	250	φ50	1	24
FCA216500		0.22	500	φ75	1	24
FCA216000		0.22	1000	φ91	1	24
FCA416150		0.45	150	φ50	1	24
FCA416250		0.45	250	φ50	1	24
FCA416500	0.45	500	φ75	1	24	
FCA416000	0.45	1000	φ91	1	24	

Cat. No.	Membrane Material	Pore Size (µm)	Capacity (mL)	Membrane Diameter (mm)	Qty. Per Bag	Qty. Per Case
SCA217150	SFCA	0.22	150	Φ50	1	24
SCA217250		0.22	250	Φ50	1	24
SCA217500		0.22	500	Φ75	1	24
SCA217000		0.22	1000	Φ91	1	24
SCA417150		0.45	150	Φ50	1	24
SCA417250		0.45	250	Φ50	1	24
SCA417500		0.45	500	Φ75	1	24
SCA417000		0.45	1000	Φ91	1	24
FPE254250	PES Express	0.22	250	Φ75	1	24

Reservoir Bottles

This product can be used with a vacuum filter as a receiving container for vacuum filtered liquids; they can also be used to store and prepare various laboratory fluids, such as culture fluids, serums, and reagents.

- ◎ Specification: 150 mL 250 mL 500 mL 1000 mL
- ◎ Materials: Bottle Body: Polystyrene (PS),
Bottle Cap: High-density Polyethylene (HDPE),
conforming to USP Class VI standards



Easy-grip design on both sides, ergonomic and easy to hold

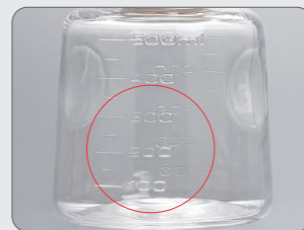

Good transparency, clearly marked scale, easy to observe capacity

Features

- ◎ 4 sizes are available: 150, 250, 500, and 1000 mL
- ◎ Made of high-quality polymer polystyrene for good transparency, strong structure and light weight
- ◎ Clear scale on the flask wall for easy observation and identification
- ◎ Designed with a wide mouth for easy pouring
- ◎ The size of the receiving flask mouth is based on that of a standard GL45 flask mouth
- ◎ Easy-grip design on both sides, ergonomic and easy to hold
- ◎ Resistant to weak acids
- ◎ Each bag is marked with the product lot number for easy quality traceability
- ◎ Sterilized by irradiation, SAL 10⁻⁶
- ◎ DNase/RNase-free, non-pyrogenic

Cat. No.	Material	Capacity (mL)	Sterile	Qty. Per Bag	Qty. Per Case
FRB000150	PS	150	Y	1	24
FRB000250		250	Y	1	24
FRB000500		500	Y	1	24
FRB000000		1000	Y	1	24

Tube Vacuum Filters System

The system uses a vacuum pump to provide differential pressure to filter tissue culture fluids and other laboratory solutions. The filtrate can be directly stored in sterile centrifuge tubes, significantly shortening the pipetting process and improving efficiency. The set includes a vacuum upper filter cup, 50 mL conical centrifuge tube, centrifuge tube holder and centrifuge tube cap.



- ◎ Membrane Pore Size: 0.22 µm 0.45 µm
- ◎ Membrane Type: MCE Nylon PVDF CA PES
- ◎ Upper Cup Capacity: 150 mL
- ◎ Lower Tube Capacity: 50 mL
- ◎ Materials: Upper filter cup: Polystyrene (PS), Green connector: Acrylonitrile-butadiene-styrene copolymer (ABS), White connector: Polypropylene (PP), conforming to USP Class VI standards

Features

- ◎ The 50 mm diameter membrane with external vacuum interface allows for direct filtration into a 50 mL centrifuge tube, reducing unnecessary pipetting steps
- ◎ Comes with an individually packaged centrifuge tube cap for easy storage
- ◎ The connector thread is attached to a standard 50 mL standing conical centrifuge tube
- ◎ The base directly secures the whole filter device
- ◎ The set includes: vacuum filter upper cup, 50 mL conical centrifuge tube, centrifuge tube holder and centrifuge tube cap
- ◎ Sterilized by irradiation, SAL 10⁻⁶
- ◎ DNase/RNase-free, non-pyrogenic

Tube Vacuum Filter System (including tube, cap and stand)

Cat. No.	Membrane Material	Pore Size (µm)	Funnel / Tube Size (mL)	Sterile	Qty. Per Bag	Qty. Per Case
FCF010001	CA	0.45	150/50	Y	1	12
FCF010002		0.22	150/50	Y	1	12
FCF010003	PES	0.45	150/50	Y	1	12
FCF010004		0.22	150/50	Y	1	12
FCF010005	MCE	0.45	150/50	Y	1	12
FCF010006		0.22	150/50	Y	1	12
FCF010007	PVDF	0.45	150/50	Y	1	12
FCF010008		0.22	150/50	Y	1	12
FCF010009	Nylon	0.45	150/50	Y	1	12
FCF010010		0.22	150/50	Y	1	12

Cat. No.	Membrane Material	Pore Size (µm)	Funnel / Tube Size (mL)	Sterile	Qty. Per Bag	Qty. Per Case
FCF000001	CA	0.45	150/50	Y	1	24
FCF000002		0.22	150/50	Y	1	24
FCF000003	PES	0.45	150/50	Y	1	24
FCF000004		0.22	150/50	Y	1	24
FCF000005	MCE	0.45	150/50	Y	1	24
FCF000006		0.22	150/50	Y	1	24
FCF000007	PVDF	0.45	150/50	Y	1	24
FCF000008		0.22	150/50	Y	1	24
FCF000009	Nylon	0.45	150/50	Y	1	24
FCF000010		0.22	150/50	Y	1	24

Tube Top Vacuum Filters

Using a vacuum pump to provide differential pressure for filtration of tissue culture fluids and other laboratory solutions, the filtrate can be directly stored in sterile centrifuge tubes, greatly shortening the pipetting process and improving efficiency. The set includes: upper cup cover, upper cup and connector.



- Membrane pore size: 0.22 µm 0.45 µm
- Membrane Type: MCE Nylon PVDF CA PES
- Upper cup capacity: 150 mL
- Materials: Upper filter cup: Polystyrene (PS), Green connector: Acrylonitrile-butadiene-styrene copolymer (ABS), White connector: Polypropylene (PP), conforming to USP Class VI standards

Features

- The 50 mm diameter membrane and external vacuum interface allows for direct filtration into a 50 mL centrifuge tube, reducing unnecessary pipetting steps
- Comes with an individually packaged centrifuge tube cap for easy storage
- Connector thread attached to a standard 50 mL standing conical centrifuge tube
- The set includes: cap of tube top vacuum filter, tube top vacuum filter, filter connector
- Sterilized by irradiation, SAL 10⁶
- DNase/RNase-free, non-pyrogenic

JetSpin® Centrifugal Filters

The JetSpin® centrifugal filters are newly upgraded filters with vertical single-sided/dual-sided filter membranes and supports. They have a larger active membrane area, higher flow rate and stronger structure for rapid filtration and concentration of samples. The filter membranes are made high-throughput polyethersulfone (PES) that has strong hydrophilicity and low protein adhesion for excellent performance. The products are strictly controlled in accordance with ISO 13485 and ISO 9001 standards, and undergo strict leak-proof and chemical compatibility tests to ensure quality.

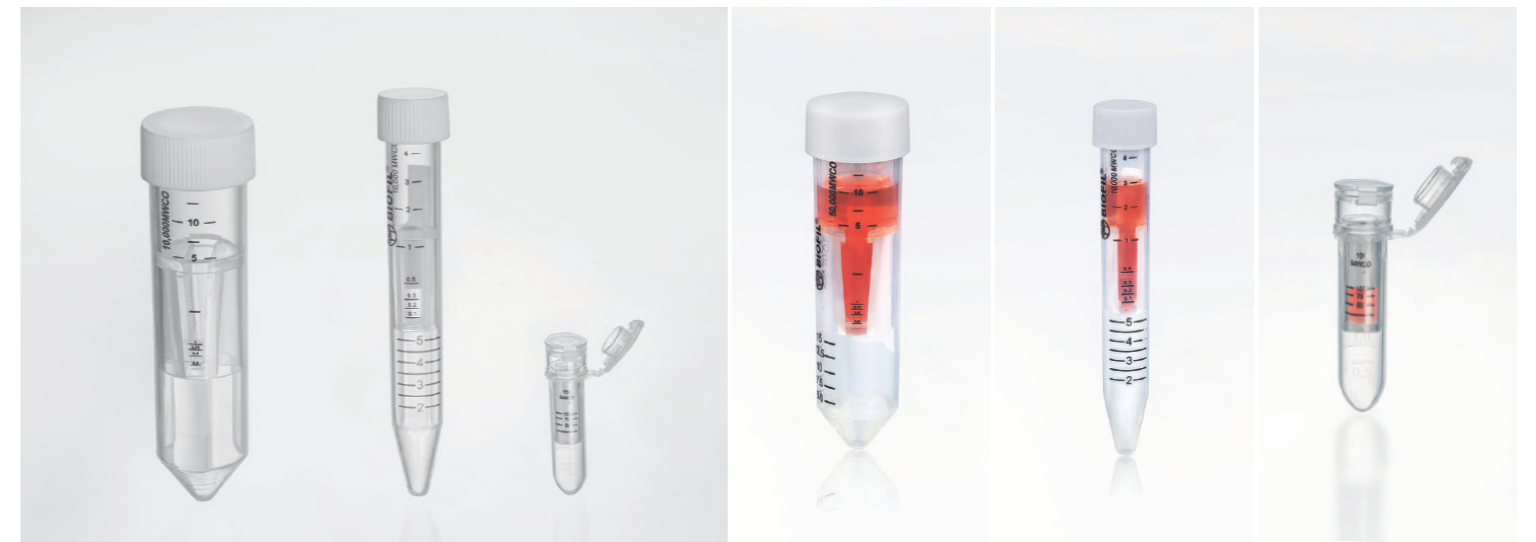

- Inner Filter Specification: 0.5mL 5mL 5mL
 - Tube Specification: 2mL 15mL 50mL
 - Molecular weight cutoff (MWCO): 5KD 10KD 30KD 50KD 100KD
- Materials: Outer tube: Polypropylene (PP), Filter: Methacrylate-butadiene-styrene (MBS), Filter membrane: Polyethersulfone (PES), Tube cap: High-density polyethylene (HDPE), conforming to USP Class VI standards

Features

- All materials conform to USP Class VI standards. In total, five molecular weight cutoff (MWCO) options are available, meeting the filtration needs for molecules of different sizes.
- The filter is structurally designed with a high-performance vertical single-(0.5 mL)/double-sided (5 mL & 15 mL) PES filtration membrane, featuring a larger effective filtration area and a higher flow rate.
- The 5 mL and 15 mL tubes are provided with supports, improving the stability of the structure, supporting a higher centrifugal speed, and reducing the filtration time.
- Protein recovery is increased to over 80%.
- There is a printed scale and a white area for writing on the tube, facilitating identification and marking.
- DNase-free, RNase-free, non-pyrogenic

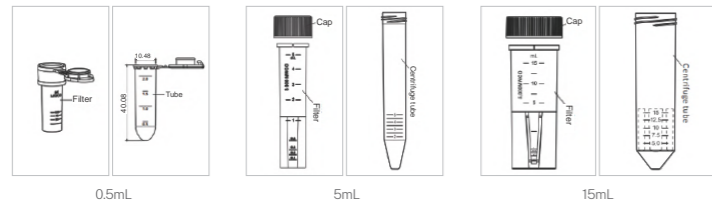

Special Tips:
The product is inapplicable to solutions containing benzene, acetone, and chloroform.

Cat. No.	Inner Filter Specification (mL)	Tube Specification (mL)	Effective Filtration Area (cm ²)	Maximum Initial Sample Volume	Sterile	MWCO (KDa)	Maximum RCF (Fixed Angle Rotor) xg	Maximum RCF (Swinging Bucket Rotor) xg	Qty. Per Box	Qty. Per Case
FTT105105	0.5	2	0.65	0.5 mL for fixed angle rotor	N	5	10000	-	25	300
FTT110105	0.5	2	0.65		N	10	10000	-	25	300
FTT130105	0.5	2	0.65		N	30	10000	-	25	300
FTT150105	0.5	2	0.65		N	50	10000	-	25	300
FTT100105	0.5	2	0.65		N	100	10000	-	25	300
FTT105150	5	15	3.5	4 mL for fixed angle rotor	N	5	5000	4000	24	96
FTT110150	5	15	3.5		N	10	5000	4000	24	96
FTT130150	5	15	3.5		N	30	5000	4000	24	96
FTT150150	5	15	3.5		N	50	5000	4000	24	96
FTT100150	5	15	3.5	5 mL for swinging bucket rotor	N	100	5000	4000	24	96
FTT405500	15	50	9.7		N	5	4000	3000	8	96
FTT505500	15	50	9.7		N	5	4000	3000	24	96
FTT410500	15	50	9.7		N	10	4000	3000	8	96
FTT510500	15	50	9.7		N	10	4000	3000	24	96
FTT430500	15	50	9.7		N	30	4000	3000	8	96
FTT530500	15	50	9.7		N	30	4000	3000	24	96
FTT450500	15	50	9.7		N	50	4000	3000	8	96
FTT550500	15	50	9.7		N	50	4000	3000	24	96
FTT400500	15	50	9.7		N	100	4000	3000	8	96
FTT500500	15	50	9.7		N	100	4000	3000	24	96



Stock Code: 688026

Molecular Biology



Molecular test is a laboratory test that is used to study constituent cells and body fluids using DNA and/or RNA detection technology to identify the molecular characteristics and abnormalities under the basic principle of PCR. Molecular tests are widely used in various fields, such as laboratories, and clinical and non-clinical fields. Molecular diagnosis, an example of the application of molecular tests for in vitro diagnosis, has currently become the fastest-growing and cutting-edge technology in the field of in vitro diagnosis. In addition to disease diagnosis, scientific research institutes, pharmaceutical companies, and CROs also use molecular test technologies and products to carry out research and development. With the development of computer technology and the advancement of precision instrument manufacturing technology, automation technology is increasingly used in molecular tests, resulting in a demand for a series of consumables supporting automation applications, including robotic tips, deep-well plates, PCR plates, etc.

Consumables for molecular tests produced by JET BIOFIL are DNase/RNase and pyrogen-free and produced in a Class 100,000 clean room with high-quality raw materials conforming to USP Class VI standards. The robotic tips have a variety of specifications, allowing them to be compatible with various automatic instruments such as those by Tecan®, Hamilton®, and Beckman®. The deep-well plates also have multiple specifications and sizes conforming to SBS standards, allowing them to be used in the corresponding automatic workstations. The PCR plates are made of high-quality polypropylene (PP) with plate types conforming to SBS, which makes them adaptive to repeated high and low-temperature settings during PCR. Moreover, the PCR plates are suitable for different PCR amplifiers from different manufacturers because of the multiple types available, including non-skirted, semi-skirted and full-skirted plates.

Pipette Micro Tips

Pipette micro tips are used to accurately transfer a small amount of liquid together with a pipette. JET BIOFIL pipette tips can be used with pipettes of most popular brands and are made of polypropylene in line with USP Class VI standards in a 100,000 grade clean room. The high material transparency ensures liquid handling accuracy. They are widely used in liquid pipetting, dispensing and mixing, and in preparing samples for assays and tests.

- ◎ Specifications: 10 μ L 20 μ L 100 μ L 200 μ L 300 μ L 1,000 μ L 1,250 μ L
- ◎ Available configuration: With filter element Without filter element
- ◎ Materials: Polypropylene (PP), Filter element: Polyolefin (PO), conforming to USP Class VI standards



Features

- ◎ Extended tips can reach the bottom of deep containers with narrow mouths without touching the inner walls of the container, thus reducing the risk of contamination
- ◎ Suitable for most brands of micropipettes, such as Gilson, Eppendorf, etc.
- ◎ Fine graduation facilitates direct visual observation of pipetting volumes
- ◎ Smooth inwall of tips reduces liquid adhesion, making it environmentally friendly and able to reduce sample usage
- ◎ Sterilized and non-sterilized available, sterilized by irradiation to SAL 10^{-6}
- ◎ DNase/RNase-free, non-pyrogenic

Pipette Micro Tips, 0.1–10 μ L

10 μ L	Cat. No.	Capacity (μ L)	Color	Filter	Sterile	Package	Qty./Bag	Qty./Case
	PPT000110	0.1–10	Natural	N	N	Re-sealable bag	1000	10000
	PPT221010	0.1–10	Natural	N	Y	Re-sealable bag	1000	10000
	PPT100010	0.1–10	Natural	Y	N	Re-sealable bag	1000	10000
	PPT101010	0.1–10	Natural	Y	Y	Re-sealable bag	1000	10000
	PPT050010	0.1–10	Natural	N	N	Rack Box	96	1920
	PPT051110	0.1–10	Natural	N	Y	Rack Box	96	1920
	PPT150010	0.1–10	Natural	Y	N	Rack Box	96	1920
	PPT151010	0.1–10	Natural	Y	Y	Rack Box	96	1920

Pipette Micro Tips, 0.1–10 μ L, Long Tips

10 μ L, Long Tips	Cat. No.	Capacity (μ L)	Color	Filter	Sterile	Package	Qty./Bag	Qty./Case
	PPT300010	0.1–10	Natural	N	N	Re-sealable bag	1000	10000
	PPT301010	0.1–10	Natural	N	Y	Re-sealable bag	1000	10000
	PPT402010	0.1–10	Natural	Y	N	Re-sealable bag	1000	10000
	PPT401010	0.1–10	Natural	Y	Y	Re-sealable bag	1000	10000
	PPT350010	0.1–10	Natural	N	N	Rack Box	96	1920
	PPT351010	0.1–10	Natural	N	Y	Rack Box	96	1920
	PPT450010	0.1–10	Natural	Y	N	Rack Box	96	1920
	PPT451010	0.1–10	Natural	Y	Y	Rack Box	96	1920

Pipette Micro Tips, 0.5–20 μ L

20 μ L(45mm)	Cat. No.	Capacity (μ L)	Color	Filter	Sterile	Package	Qty./Bag	Qty./Case
	PPT520020	0.5–20	Natural	Y	N	Re-sealable bag	1000	10000
	PPT521020	0.5–20	Natural	Y	Y	Re-sealable bag	1000	10000
	PPT510020	0.5–20	Natural	Y	N	Rack Box	96	1920
	PPT511020	0.5–20	Natural	Y	Y	Rack Box	96	1920
	PPT530020	0.5–20	Natural	N	N	Re-sealable bag	1000	10000
	PPT531020	0.5–20	Natural	N	Y	Re-sealable bag	1000	10000
	PPT500020	0.5–20	Natural	N	N	Rack Box	96	1920
	PPT501020	0.5–20	Natural	N	Y	Rack Box	96	1920

Pipette Micro Tips, 2–20 μ L

20 μ L(51mm)	Cat. No.	Capacity (μ L)	Color	Filter	Sterile	Package	Qty./Bag	Qty./Case
	PPT100020	2–20	Natural	Y	N	Re-sealable bag	1000	10000
	PPT101020	2–20	Natural	Y	Y	Re-sealable bag	1000	10000
	PPT150020	2–20	Natural	Y	N	Rack Box	96	1920
	PPT151020	2–20	Natural	Y	Y	Rack Box	96	1920

Pipette Micro Tips, 10–100 µL

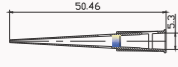
100µL	Cat. No.	Capacity (µL)	Color	Filter	Sterile	Package	Qty./Bag	Qty./Case
	PPT100100	10–100	Natural	Y	N	Re-sealable bag	1000	10000
	PPT101100	10–100	Natural	Y	Y	Re-sealable bag	1000	10000
	PPT150100	10–100	Natural	Y	N	Rack Box	96	1920
	PPT151100	10–100	Natural	Y	Y	Rack Box	96	1920

Pipette Micro Tips, 10–200 µL

200µL	Cat. No.	Capacity (µL)	Color	Filter	Sterile	Package	Qty./Bag	Qty./Case
 With Filter  Without Filter	PPT000200	10–200	Natural	N	N	Re-sealable bag	1000	10000
	PPT000200-1	10–200	Yellow	N	N	Re-sealable bag	1000	10000
	PPT001200	10–200	Natural	N	Y	Re-sealable bag	1000	10000
	PPT001200-1	10–200	Yellow	N	Y	Re-sealable bag	1000	10000
	PPT150200	10–200	Natural	Y	N	Re-sealable bag	1000	10000
	PPT050200	10–200	Natural	N	N	Rack Box	1000	10000
	PPT051200	10–200	Natural	N	Y	Rack Box	96	1920
	PPT153200	10–200	Natural	Y	Y	Rack Box	96	1920
	PPT151200	10–200	Natural	Y	Y	Re-sealable bag	1000	10000
	PPT152200	10–200	Natural	Y	N	Rack Box	96	1920

Pipette Micro Tips, 10–300 µL

300µL	Cat. No.	Capacity (µL)	Color	Filter	Sterile	Package	Qty./Bag	Qty./Case
	PPT300300	10–300	Natural	N	N	Re-sealable bag	1000	10000
	PPT301300	10–300	Natural	N	Y	Re-sealable bag	1000	10000
	PPT401300	10–300	Natural	Y	Y	Re-sealable bag	1000	10000
	PPT402300	10–300	Natural	Y	N	Re-sealable bag	1000	10000
	PPT350300	10–300	Natural	N	N	Rack Box	96	1920
	PPT351300	10–300	Natural	N	Y	Rack Box	96	1920
	PPT450300	10–300	Natural	Y	N	Rack Box	96	1920
	PPT451300	10–300	Natural	Y	Y	Rack Box	96	1920

Pipette Micro Tips, 100–1000 µL

1000µL	Cat. No.	Capacity (µL)	Color	Filter	Sterile	Package	Qty./Bag	Qty./Case
	PPT000000	100–1000	Natural	N	N	Re-sealable bag	1000	10000
	PPT000000-1	100–1000	Blue	N	N	Re-sealable bag	1000	10000
	PPT001000	100–1000	Natural	N	Y	Re-sealable bag	1000	10000
	PPT001000-1	100–1000	Blue	N	Y	Re-sealable bag	1000	10000
	PPT100000	100–1000	Natural	Y	N	Re-sealable bag	1000	10000
	PPT101000	100–1000	Natural	Y	Y	Re-sealable bag	1000	10000
	PPT050000	100–1000	Natural	N	N	Rack Box	96	1920
	PPT051000	100–1000	Natural	N	Y	Rack Box	96	1920
	PPT150000	100–1000	Natural	Y	N	Rack Box	96	1920
	PPT151000	100–1000	Natural	Y	Y	Rack Box	96	1920

Pipette Micro Tips, 100–1000 µL, Long Tips

1000µL, Long	Cat. No.	Capacity (µL)	Color	Filter	Sterile	Package	Qty. Per Bag	Qty. Per Case
	PPT070000	100–1000	Natural	N	N	Re-sealable bag	1000	10000
	PPT070000-1	100–1000	Blue	N	N	Re-sealable bag	1000	10000
	PPT071000	100–1000	Natural	N	Y	Re-sealable bag	1000	10000
	PPT071000-1	100–1000	Blue	N	Y	Re-sealable bag	1000	10000
	PPT170000	100–1000	Natural	Y	N	Re-sealable bag	1000	10000
	PPT171000	100–1000	Natural	Y	Y	Re-sealable bag	1000	10000
	PPT270000	100–1000	Natural	N	N	Rack Box	96	1920
	PPT271000	100–1000	Natural	N	Y	Rack Box	96	1920
	PPT370000	100–1000	Natural	Y	N	Rack Box	96	1920
	PPT371000	100–1000	Natural	Y	Y	Rack Box	96	1920

Pipette Micro Tips, 100–1250 µL

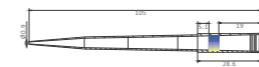
1250µL	Cat. No.	Capacity (µL)	Color	Filter	Sterile	Package	Qty. Per Bag	Qty. Per Case
	PPT371250	100–1250	Natural	Y	Y	Rack Box	96	1920

Pipette Micro Tips, 96 Per Bag

96 Per Bag	Cat. No.	Capacity (μL)	Color	Filter	Sterile	Package	Qty. Per Box	Qty. Per Case
	PPT611010	0.1-10	Natural	N	Y	Re-sealable bag	96	1920
	PPT631010	0.1-10	Natural	N	Y	Re-sealable bag	96	1920
	PPT601200	10-200	Natural	N	Y	Re-sealable bag	96	1920
	PPT601200-1	10-200	Yellow	N	Y	Re-sealable bag	96	1920
	PPT631300	10-300	Natural	N	Y	Re-sealable bag	96	1920
	PPT601000	100-1000	Natural	N	Y	Re-sealable bag	96	1920
	PPT601000-1	100-1000	Blue	N	Y	Re-sealable bag	96	1920
	PPT701010	0.1-10	Natural	Y	Y	Re-sealable bag	96	1920
	PPT703010	0.1-10	Natural	Y	Y	Re-sealable bag	96	1920
	PPT701020	2-20	Natural	Y	Y	Re-sealable bag	96	1920
	PPT701100	10-100	Natural	Y	Y	Re-sealable bag	96	1920
	PPT701200	10-200	Natural	Y	Y	Re-sealable bag	96	1920
	PPT701300	10-300	Natural	Y	Y	Re-sealable bag	96	1920
	PPT701000	100-1000	Natural	Y	Y	Re-sealable bag	96	1920

Pipette MicroTips, Reloading Rack

Reloading Rack	Cat. No.	Capacity (μL)	Color	Filter	LayerQty.	Sterile	Package	Qty. Per Box	Qty. Per Case
	PPT900010	0.1-10	Natural	N	10	N	Rack Box	960	9600
	PPT900200	10-200	Natural	N	10	N	Rack Box	960	9600
	PPT901200	10-200	Yellow	N	10	N	Rack Box	960	9600
	PPT900300	10-300	Natural	N	10	N	Rack Box	960	9600
	PPT900000	100-1000	Natural	N	5	N	Rack Box	480	4800
	PPT901000	100-1000	Blue	N	5	N	Rack Box	480	4800

ZEROTIP® Pipette Micro Tips

The tips are designed with a superhydrophobic surface so as to reduce liquid adsorption, improve accuracy and precision, and reduce reagent loss. They are therefore particularly suited to cell culture experiments, genomics, enzyme reactions, nucleic acid extraction and purification, proteomics, and protein extraction and purification.

- ◎ Specification: 10 μL 20 μL 100 μL 200 μL 300 μL 1,000 μL 1,250 μL
- ◎ Available configuration: With filter element Without filter element
- ◎ Materials: Polypropylene (PP), Filter element: Polyolefin (PO), conforming to USP Class VI standards

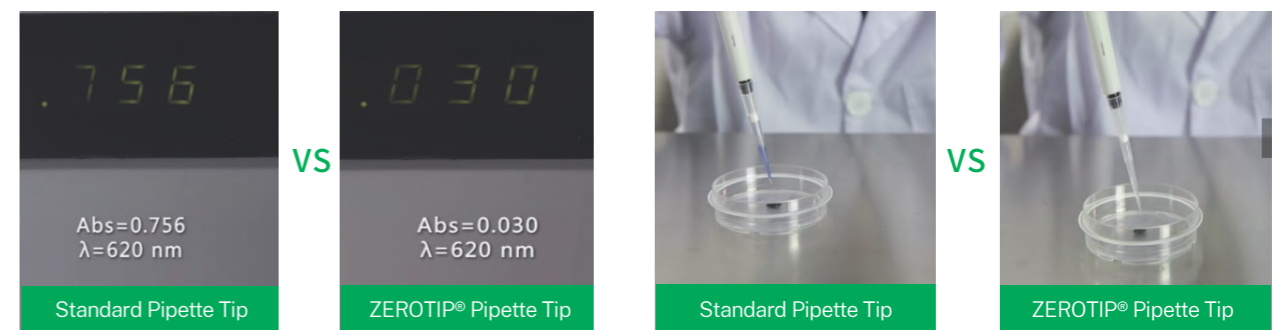
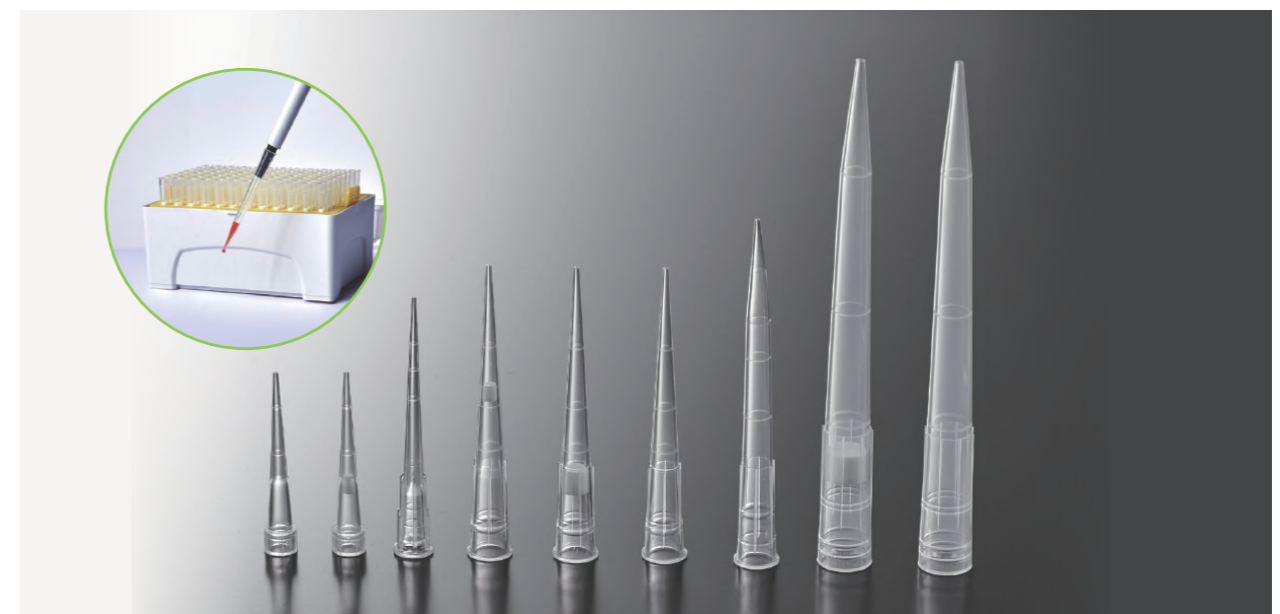

Features

- ◎ Smooth superhydrophobic surface reduces sample loss and improves accuracy and precision
- ◎ Minimizes foam formation during pipetting
- ◎ Suitable for operations involving biological samples, such as detergents and solvents, including SDS, Tween and Triton X-100.
- ◎ Extremely high reproducibility in PCR and real-time PCR applications
- ◎ Compatible with most micropipettes, such as Gilson, Eppendorf, etc.
- ◎ Sterilized and non-sterilized available, sterilized by irradiation to SAL 10⁻⁶
- ◎ DNase/RNase-free, Non-pyrogenic

ZEROTIP® Pipette Micro Tips, 0.1-10 µL

10µL	Cat. No.	Capacity(µL)	Color	Filter	Sterile	Package	Qty. Per Bag(Box)	Qty. Per Case
	PMT010010	0.1-10	Natural	N	N	Re-sealable bag	1000	10000
	PMT011010	0.1-10	Natural	N	Y	Re-sealable bag	1000	10000
	PMT110010	0.1-10	Natural	Y	N	Re-sealable bag	1000	10000
	PMT111010	0.1-10	Natural	Y	Y	Re-sealable bag	1000	10000
	PMT250010	0.1-10	Natural	N	N	Rack Box	96	1920
	PMT251010	0.1-10	Natural	N	Y	Rack Box	96	1920
	PMT550010	0.1-10	Natural	Y	N	Rack Box	96	1920
	PMT252010	0.1-10	Natural	Y	Y	Rack Box	96	1920

ZEROTIP® Pipette Micro Tips, 0.1-10 µL, Long Tips

10µL, Long Tips	Cat. No.	Capacity(µL)	Color	Filter	Sterile	Package	Qty. Per Bag(Box)	Qty. Per Case
	PMT030010	0.1-10	Natural	N	N	Re-sealable bag	1000	10000
	PMT031010	0.1-10	Natural	N	Y	Re-sealable bag	1000	10000
	PMT130010	0.1-10	Natural	Y	N	Re-sealable bag	1000	10000
	PMT131010	0.1-10	Natural	Y	Y	Re-sealable bag	1000	10000
	PMT230010	0.1-10	Natural	N	N	Rack Box	96	1920
	PMT231010	0.1-10	Natural	N	Y	Rack Box	96	1920
	PMT232010	0.1-10	Natural	Y	N	Rack Box	96	1920
	PMT233010	0.1-10	Natural	Y	Y	Rack Box	96	1920

ZEROTIP® Pipette Micro Tips, 0.5-20 µL

20µL(45mm)	Cat. No.	Capacity(µL)	Color	Filter	Sterile	Package	Qty. Per Bag(Box)	Qty. Per Case
	PMT520020	0.5-20	Natural	Y	N	Re-sealable bag	1000	10000
	PMT521020	0.5-20	Natural	Y	Y	Re-sealable bag	1000	10000
	PMT510020	0.5-20	Natural	Y	N	Rack Box	96	1920
	PMT511020	0.5-20	Natural	Y	Y	Rack Box	96	1920
	PMT530020	0.5-20	Natural	N	N	Re-sealable bag	1000	10000
	PMT531020	0.5-20	Natural	N	Y	Re-sealable bag	1000	10000
	PMT500020	0.5-20	Natural	N	N	Rack Box	96	1920
	PMT501020	0.5-20	Natural	N	Y	Rack Box	96	1920

ZEROTIP® Pipette Micro Tips, 2-20 µL

20µL(51mm)	Cat. No.	Capacity(µL)	Color	Filter	Sterile	Package	Qty. Per Bag(Box)	Qty. Per Case
	PMT110020	2-20	Natural	Y	N	Re-sealable bag	1000	10000
	PMT111020	2-20	Natural	Y	Y	Re-sealable bag	1000	10000
	PMT250020	2-20	Natural	Y	N	Rack Box	96	1920
	PMT252020	2-20	Natural	Y	Y	Rack Box	96	1920

ZEROTIP® Pipette Micro Tips, 10-100 µL

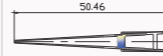
	Cat. No.	Capacity (µL)	Color	Filter	Sterile	Package	Qty. Per Bag(Box)	Qty. Per Case
	PMT110100	10-100	Natural	Y	N	Re-sealable bag	1000	10000
	PMT111100	10-100	Natural	Y	Y	Re-sealable bag	1000	10000
	PMT250100	10-100	Natural	Y	N	Rack Box	96	1920
	PMT252100	10-100	Natural	Y	Y	Rack Box	96	1920

ZEROTIP® Pipette Micro Tips, 10-200 µL

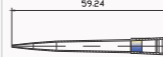
	Cat. No.	Capacity (µL)	Color	Filter	Sterile	Package	Qty. Per Bag(Box)	Qty. Per Case
	PMT010200	10-200	Natural	N	N	Re-sealable bag	1000	10000
	PMT011200	10-200	Natural	N	Y	Re-sealable bag	1000	10000
	PMT012200	10-200	Natural	Y	N	Re-sealable bag	1000	10000
	PMT111200	10-200	Natural	Y	Y	Re-sealable bag	1000	10000
	PMT250200	10-200	Natural	N	N	Rack Box	96	1920
	PMT251200	10-200	Natural	N	Y	Rack Box	96	1920
	PMT230200	10-200	Natural	Y	N	Rack Box	96	1920
	PMT231200	10-200	Natural	Y	Y	Rack Box	96	1920

ZEROTIP® Pipette Micro Tips, 10-300 µL

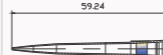
	Cat. No.	Capacity (µL)	Color	Filter	Sterile	Package	Qty. Per Bag(Box)	Qty. Per Case
	PMT030300	10-300	Natural	N	N	Re-sealable bag	1000	10000
	PMT031300	10-300	Natural	N	Y	Re-sealable bag	1000	10000
	PMT130300	10-300	Natural	Y	N	Re-sealable bag	1000	10000
	PMT131300	10-300	Natural	Y	Y	Re-sealable bag	1000	10000
	PMT230300	10-300	Natural	N	N	Rack Box	96	1920
	PMT231300	10-300	Natural	N	Y	Rack Box	96	1920
	PMT232300	10-300	Natural	Y	N	Rack Box	96	1920
	PMT233300	10-300	Natural	Y	Y	Rack Box	96	1920

ZEROTIP® Pipette Micro Tips, 100-1000 µL

	Cat. No.	Capacity (µL)	Color	Filter	Sterile	Package	Qty. Per Bag(Box)	Qty. Per Case
	PMT010000	100-1000	Natural	N	N	Re-sealable bag	1000	10000
	PMT011000	100-1000	Natural	N	Y	Re-sealable bag	1000	10000
	PMT110000	100-1000	Natural	Y	N	Re-sealable bag	1000	10000
	PMT111000	100-1000	Natural	Y	Y	Re-sealable bag	1000	10000
	PMT250000	100-1000	Natural	N	N	Rack Box	96	1920
	PMT251000	100-1000	Natural	N	Y	Rack Box	96	1920
	PMT550000	100-1000	Natural	Y	N	Rack Box	96	1920
	PMT252000	100-1000	Natural	Y	Y	Rack Box	96	1920

ZEROTIP® Pipette Micro Tips, 100-1000 µL Long Tips

	Cat. No.	Capacity (µL)	Color	Filter	Sterile	Package	Qty. Per Bag(Box)	Qty. Per Case
	PMT070000	100-1000	Natural	N	N	Re-sealable bag	1000	10000
	PMT071000	100-1000	Natural	N	Y	Re-sealable bag	1000	10000
	PMT170000	100-1000	Natural	Y	N	Re-sealable bag	1000	10000
	PMT171000	100-1000	Natural	Y	Y	Re-sealable bag	1000	10000
	PMT270000	100-1000	Natural	N	N	Rack Box	96	1920
	PMT271000	100-1000	Natural	N	Y	Rack Box	96	1920
	PMT370000	100-1000	Natural	Y	N	Rack Box	96	1920
	PMT371000	100-1000	Natural	Y	Y	Rack Box	96	1920

Reloading Rack, Pipette Micro Tips

	Cat. No.	Capacity (µL)	Color	LayerQty.	Filter	Sterile	Package	Qty. Per Bag(Box)	Qty. Per Case
	PMT950010	0.1-10	Natural	10	N	N	Rack Box	960	9600
	PMT950200	10-200	Natural	10	N	N	Rack Box	960	9600
	PMT951200	10-200	Yellow	10	N	N	Rack Box	960	9600
	PMT950300	10-300	Natural	10	N	N	Rack Box	960	9600
	PMT950000	100-1000	Natural	5	N	N	Rack Box	480	4800
	PMT951000	100-1000	Blue	5	N	N	Rack Box	480	4800

Robotic Tips

The robotic tips and non-conductive tips are designed for use in robotic pipetting systems and can be used in various liquid handling workstations, such as those produced by Beckman, Tecan and Agilent. They can also be applied to cytomics, genomics, proteomics, immunoassay, metabonomics and the R&D of bio-pharmaceuticals as well as other commonly used high-throughput liquid handling.

- Range of tip capacity: 10 µL-1000 µL
- Available configurations: With filter element
Without filter element
- Treatment: Non-treated Low Retention Treated
- Materials: Polypropylene (PP), conforming to USP Class VI standards

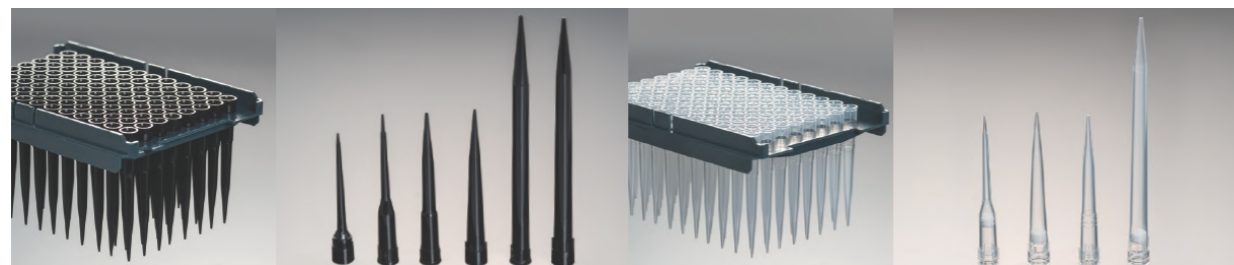

Features

- Made of high quality PP for stable performance
- Two types available (with and without filter element) to meet different testing requirements
- Exclusive technology – smooth inner surface and excellent concentricity of tips, significantly reducing residues
- Standard size and excellent air tightness
- Highly compatibility for use with a wide range of liquid handling workstations
- Sterilized by e-beam and passed SGS verification
- Sterilized and non-sterilized available, sterilized by irradiation to SAL 10⁻⁶
- DNase/RNase-free, non-pyrogenic

Tecan® Genesis Freedom®, Freedom Evo® and Miniprep with LiHa

	Cat. No.	Max Volume (µL)	Surface Type	Sterile	Filter	Color	Package	Qty. Per Box	Qty. Per Case
	ATT101010	10	Normal	Y	Y	Natural	Rack Box	96	2304
	AMT101010	10	Low Retention	Y	Y	Natural	Rack Box	96	2304
	ATT000020	20	Normal	N	N	Natural	Rack Box	96	2304
	AMT000020	20	Low Retention	N	N	Natural	Rack Box	96	2304
	ATT001020	20	Normal	Y	N	Natural	Rack Box	96	2304
	AMT001020	20	Low Retention	Y	N	Natural	Rack Box	96	2304
	ATT000050	50	Normal	N	N	Natural	Rack Box	96	2304
	AMT000050	50	Low Retention	N	N	Natural	Rack Box	96	2304
	ATT001050	50	Normal	Y	N	Natural	Rack Box	96	2304
	AMT001050	50	Low Retention	Y	N	Natural	Rack Box	96	2304
	ATT101050	50	Normal	Y	Y	Natural	Rack Box	96	2304
	AMT101050	50	Low Retention	Y	Y	Natural	Rack Box	96	2304
	ATT000200	200	Normal	N	N	Natural	Rack Box	96	2304
	AMT000200	200	Low Retention	N	N	Natural	Rack Box	96	2304
	ATT001200	200	Normal	Y	N	Natural	Rack Box	96	2304
	AMT001200	200	Low Retention	Y	N	Natural	Rack Box	96	2304
	ATT101200	200	Normal	Y	Y	Natural	Rack Box	96	2304
	AMT101200	200	Low Retention	Y	Y	Natural	Rack Box	96	2304
	ATT000000	1000	Normal	N	N	Natural	Rack Box	96	1536
	AMT000000	1000	Low Retention	N	N	Natural	Rack Box	96	1536
ATT001000	1000	Normal	Y	N	Natural	Rack Box	96	1536	
AMT001000	1000	Low Retention	Y	N	Natural	Rack Box	96	1536	
ATT101000	1000	Normal	Y	Y	Natural	Rack Box	96	1536	
AMT101000	1000	Low Retention	Y	Y	Natural	Rack Box	96	1536	

Tecan® Genesis Freedom®, Freedom Evo® and Miniprep with LiHa

Cat. No.	Max Volume (µL)	Surface Type	Sterile	Filter	Color	Package	Qty. Per Box	Qty. Per Case
AUT101010	10	Normal	Y	Y	Black	Rack Box	96	2304
ANT101010	10	Low Retention	Y	Y	Black	Rack Box	96	2304
AUT000020	20	Normal	N	N	Black	Rack Box	96	2304
ANT000020	20	Low Retention	N	N	Black	Rack Box	96	2304
AUT001020	20	Normal	Y	N	Black	Rack Box	96	2304
ANT001020	20	Low Retention	Y	N	Black	Rack Box	96	2304
AUT000050	50	Normal	N	N	Black	Rack Box	96	2304
ANT000050	50	Low Retention	N	N	Black	Rack Box	96	2304
AUT001050	50	Normal	Y	N	Black	Rack Box	96	2304
ANT001050	50	Low Retention	Y	N	Black	Rack Box	96	2304
AUT101050	50	Normal	Y	Y	Black	Rack Box	96	2304
ANT101050	50	Low Retention	Y	Y	Black	Rack Box	96	2304
AUT000200	200	Normal	N	N	Black	Rack Box	96	2304
ANT000200	200	Low Retention	N	N	Black	Rack Box	96	2304
AUT001200	200	Normal	Y	N	Black	Rack Box	96	2304
ANT001200	200	Low Retention	Y	N	Black	Rack Box	96	2304
AUT101200	200	Normal	Y	Y	Black	Rack Box	96	2304
ANT101200	200	Low Retention	Y	Y	Black	Rack Box	96	2304
AUT000000	1000	Normal	N	N	Black	Rack Box	96	1536
ANT000000	1000	Low Retention	N	N	Black	Rack Box	96	1536
AUT001000	1000	Normal	Y	N	Black	Rack Box	96	1536
ANT001000	1000	Low Retention	Y	N	Black	Rack Box	96	1536
AUT101000	1000	Normal	Y	Y	Black	Rack Box	96	1536
ANT101000	1000	Low Retention	Y	Y	Black	Rack Box	96	1536

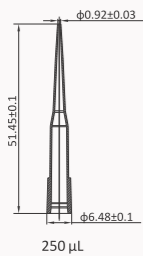
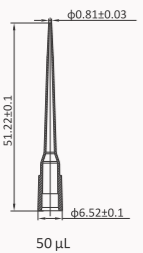
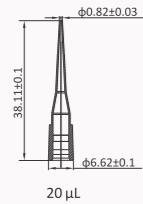

Beckman, FX/NX, Multimek AP96 and Biomek3000

Cat. No.	Max Volume(µL)	Surface Type	Sterile	Filter	Color	Package	Qty. Per Box	Qty. Per Case
ATB000020	20	Normal	N	N	Natural	Rack Box	96	4800
AMB000020	20	Low Retention	N	N	Natural	Rack Box	96	4800
ATB001020	20	Normal	Y	N	Natural	Rack Box	96	4800
AMB001020	20	Low Retention	Y	N	Natural	Rack Box	96	4800
ATB101020	20	Normal	Y	Y	Natural	Rack Box	96	4800
AMB101020	20	Low Retention	Y	Y	Natural	Rack Box	96	4800
ATB000050	50	Normal	N	N	Natural	Rack Box	96	4800
AMB000050	50	Low Retention	N	N	Natural	Rack Box	96	4800
ATB001050	50	Normal	Y	N	Natural	Rack Box	96	4800

Cat. No.	Max Volume (µL)	Surface Type	Sterile	Filter	Color	Package	Qty. Per Box	Qty. Per Case
AMB001050	50	Low Retention	Y	N	Natural	Rack Box	96	4800
ATB101050	50	Normal	Y	Y	Natural	Rack Box	96	4800
AMB101050	50	Low Retention	Y	Y	Natural	Rack Box	96	4800
ATB000250	250	Normal	N	N	Natural	Rack Box	96	4800
AMB000250	250	Low Retention	N	N	Natural	Rack Box	96	4800
ATB001250	250	Normal	Y	N	Natural	Rack Box	96	4800
AMB001250	250	Low Retention	Y	N	Natural	Rack Box	96	4800
ATB101180	250	Normal	Y	Y	Natural	Rack Box	96	4800
AMB101180	250	Low Retention	Y	Y	Natural	Rack Box	96	4800

BECKMAN, FX/NX, Multimek AP96 and Biomek3000

Cat. No.	Max Volume (µL)	Surface Type	Sterile	Filter	Color	Package	Qty. Per Box	Qty. Per Case
AUB000020	20	Normal	N	N	Black	Rack Box	96	4800
ANB000020	20	Low Retention	N	N	Black	Rack Box	96	4800
AUB001020	20	Normal	Y	N	Black	Rack Box	96	4800
ANB001020	20	Low Retention	Y	N	Black	Rack Box	96	4800
AUB101020	20	Normal	Y	Y	Black	Rack Box	96	4800
ANB101020	20	Low Retention	Y	Y	Black	Rack Box	96	4800
AUB000050	50	Normal	N	N	Black	Rack Box	96	4800
ANB000050	50	Low Retention	N	N	Black	Rack Box	96	4800
AUB001050	50	Normal	Y	N	Black	Rack Box	96	4800
ANB001050	50	Low Retention	Y	N	Black	Rack Box	96	4800
AUB101050	50	Normal	Y	Y	Black	Rack Box	96	4800
ANB101050	50	Low Retention	Y	Y	Black	Rack Box	96	4800
AUB000250	250	Normal	N	N	Black	Rack Box	96	4800
ANB000250	250	Low Retention	N	N	Black	Rack Box	96	4800
AUB001250	250	Normal	Y	N	Black	Rack Box	96	4800
ANB001250	250	Low Retention	Y	N	Black	Rack Box	96	4800
AUB101180	250	Normal	Y	Y	Black	Rack Box	96	4800
ANB101180	250	Low Retention	Y	Y	Black	Rack Box	96	4800

Hamilton STAR, STARlet, STARplus and Nimbus®

Cat. No.	Max Volume (µL)	Surface Type	Sterile	Filter	Color	Package	Qty. Per Box	Qty. Per Case
ATH000050	50	Normal	N	N	Natural	Rack Box	96	2304
AMH000050	50	Low Retention	N	N	Natural	Rack Box	96	2304

	Cat. No.	Max Volume (μL)	Surface Type	Sterile	Filter	Color	Package	Qty. Per Box	Qty. Per Case
	ATH001050	50	Normal	Y	N	Natural	Rack Box	96	2304
	AMH001050	50	Low Retention	Y	N	Natural	Rack Box	96	2304
	ATH101050	50	Normal	Y	Y	Natural	Rack Box	96	2304
	AMH101050	50	Low Retention	Y	Y	Natural	Rack Box	96	2304
	ATH000300	300	Normal	N	N	Natural	Rack Box	96	2304
	AMH000300	300	Low Retention	N	N	Natural	Rack Box	96	2304
	ATH001300	300	Normal	Y	N	Natural	Rack Box	96	2304
	AMH001300	300	Low Retention	Y	N	Natural	Rack Box	96	2304
	ATH101300	300	Normal	Y	Y	Natural	Rack Box	96	2304
	AMH101300	300	Low Retention	Y	Y	Natural	Rack Box	96	2304
	ATH000000	1000	Normal	N	N	Natural	Rack Box	96	1536
	AMH000000	1000	Low Retention	N	N	Natural	Rack Box	96	1536
	ATH001000	1000	Normal	Y	N	Natural	Rack Box	96	1536
	AMH001000	1000	Low Retention	Y	N	Natural	Rack Box	96	1536
	ATH101000	1000	Normal	Y	Y	Natural	Rack Box	96	1536
	AMH101000	1000	Low Retention	Y	Y	Natural	Rack Box	96	1536

Hamilton STAR, STARlet, STARplus and Nimbus®

	Cat. No.	Max Volume (μL)	Surface Type	Sterile	Filter	Color	Package	Qty. Per Box	Qty. Per Case
	AUH000050	50	Normal	N	N	Black	Rack Box	96	2304
	ANH000050	50	Low Retention	N	N	Black	Rack Box	96	2304
	AUH001050	50	Normal	Y	N	Black	Rack Box	96	2304
	ANH001050	50	Low Retention	Y	N	Black	Rack Box	96	2304
	AUH101050	50	Normal	Y	Y	Black	Rack Box	96	2304
	ANH101050	50	Low Retention	Y	Y	Black	Rack Box	96	2304
	AUH000300	300	Normal	N	N	Black	Rack Box	96	2304
	ANH000300	300	Low Retention	N	N	Black	Rack Box	96	2304
	AUH001300	300	Normal	Y	N	Black	Rack Box	96	2304
	ANH001300	300	Low Retention	Y	N	Black	Rack Box	96	2304
	AUH101300	300	Normal	Y	Y	Black	Rack Box	96	2304
	ANH101300	300	Low Retention	Y	Y	Black	Rack Box	96	2304
	AUH000000	1000	Normal	N	N	Black	Rack Box	96	1536
	ANH000000	1000	Low Retention	N	N	Black	Rack Box	96	1536
	AUH001000	1000	Normal	Y	N	Black	Rack Box	96	1536
	ANH001000	1000	Low Retention	Y	N	Black	Rack Box	96	1536
AUH101000	1000	Normal	Y	Y	Black	Rack Box	96	1536	
ANH101000	1000	Low Retention	Y	Y	Black	Rack Box	96	1536	

Micro Centrifuge Tubes

Micro centrifuge tubes are mainly used for small amounts of sample storage, transport, and centrifugation, and have wide applications such as molecular biology, clinical chemistry and biochemical research. JET BIOFIL micro centrifuge tubes are made of transparent polypropylene (PP) and are ergonomically designed with a snap flat cap that is easy to open and close, and can be operated with one hand.

- ◎ Specification: 0.5 mL 1.5 mL 2.0 mL 5.0 mL
- ◎ Bottom Type: Conical Self-standing
- ◎ Packaging: Bag (Box)
- ◎ Materials: Polypropylene (PP), conforming to USP Class VI standards



Features

- ◎ 4 capacities available: 0.5 mL, 1.5 mL, 2.0 mL, 5.0 mL, recognized according to different colors on the tube body for convenient operation
- ◎ Conical bottom, smooth and transparent tube body with clear graduation
- ◎ The tube body is designed with a frosted writing area that is convenient for recording
- ◎ The sealing cap can be opened and closed repeatedly, which improves sealing performance, prevent liquid leakage, and is easy to operate with one hand
- ◎ Maximum RCF of up to 25,000 ×g
- ◎ Temperature range: -80°C-121°C (no deformation after high temperature sterilization with the cap open, and remains highly transparency)
- ◎ Sterilized and non-sterilized available, sterilized by irradiation to SAL 10⁻⁶
- ◎ DNase/RNase-free, non-pyrogenic

Micro Centrifuge Tubes

Cat. No.	Capacity (mL)	Color	Sterile	Qty. Per Box (Bag)	Qty. Per Case
CFT000005	0.5	Natural	N	1000	8000
CFT000015	1.5	Natural	N	500	4000
CFT000020	2.0	Natural	N	500	4000
CFT022050	5.0	Natural	N	200	4000
CFT001005	0.5	Natural	Y	1000	8000
CFT001015	1.5	Natural	Y	500	4000
CFT001020	2.0	Natural	Y	500	4000
CFT002050	5.0	Natural	Y	200	4000
CFT000050	5.0	Natural	N	180	1800
CFT023050	5.0	Blue	N	200	4000
CFT024050	5.0	Yellow	N	200	4000
CFT025050	5.0	Green	N	200	4000
CFT026050	5.0	Rose Red	N	200	4000
CFT020050	5.0	Black	N	200	4000
CFT010050	5.0	Yellow	N	250	2500
CFT001050	5.0	Natural	Y	180	1800
CFT013050	5.0	Natural	Y	60	1800
CFT003050	5.0	Blue	Y	200	4000
CFT004050	5.0	Yellow	Y	200	4000
CFT005050	5.0	Green	Y	200	4000
CFT006050	5.0	Rose Red	Y	200	4000
CFT021050	5.0	Black	Y	200	4000
CFT011050	5.0	Yellow	Y	250	2500

Micro Centrifuge Tubes (with Screw Cap)

Cat. No.	Capacity (mL)	Color	Bottom	Sterile	With Cap	Qty. Per Box (Bag)	Qty. Per Case
CFT002005	0.5	Natural	Conical	N	N	500	5000
CFT003005	0.5	Natural	Conical	Y	Y	500	5000
CFT004005	0.5	Natural	Self-standing	N	N	500	5000
CFT005005	0.5	Natural	Self-standing	Y	Y	500	5000
CFT005015	1.5	Natural	Conical	N	N	500	5000
CFT006015	1.5	Natural	Conical	Y	Y	500	5000
CFT007015	1.5	Natural	Self-standing	N	N	500	5000
CFT008015	1.5	Natural	Self-standing	Y	Y	500	5000
CFT002020	2.0	Natural	Conical	N	N	500	5000
CFT003020	2.0	Natural	Conical	Y	Y	500	5000
CFT004020	2.0	Natural	Self-standing	N	N	500	5000
CFT005020	2.0	Natural	Self-standing	Y	Y	500	5000
CFT511020	2.0	Natural	Self-standing	Y	Y	500	5000
CFT511320	2.0	Blue	Self-standing	Y	Y	500	5000
CFT511420	2.0	Yellow	Self-standing	Y	Y	500	5000

Micro Centrifuge Tubes (Long-Arm Lid)

Cat. No.	Capacity (mL)	with Cap	Sterile	Packaging	Qty. Per Bag	Qty. Per Case
CFT108015	1.5	Y	N	Bag	50	5000
CFT108020	2.0	Y	N	Bag	50	5000

Micro Centrifuge Tubes (without Cap)

Cat. No.	Capacity (mL)	with Cap	Sterile	Packaging	Qty. Per Bag	Qty. Per Case
CFT008020	1.5	N	N	Bag	1000	5000

Lid Lock Micro Centrifuge Tubes

Made of transparent polymer, polypropylene (PP), the centrifuge tubes are designed with a lid lock to provide better sealability for sample protection, and to avoid accidental opening of the cap and evaporation of samples during long-term storage, ensuring safe operations.

- Specification: 0.5 mL 1.5 mL 2.0 mL 5.0 mL
- Materials: Polypropylene (PP), conforming to USP Class VI standards
- Packaging: Bag(Box) Bulk



Features

- 4 volumes available: 0.5 mL, 1.5 mL, 2.0 mL and 5.0 mL; different colors are provided for identification
- Sharp bottom, smooth and transparent tube with a clear scale to facilitate volume reading
- The tube is designed with a frosted area to record experimental data
- Lid lock prevents accidental opening of cap and evaporation of samples during long-term storage, and ensures safe operations
- Maximum RCF of up to 25,000 ×g
- Temperature range: -80°C–121°C (does not deform after high-temperature sterilization and remains highly transparent)
- Sterilized by irradiation, SAL 10⁻⁶
- DNase/RNase-free, non-pyrogenic

Micro Centrifuge Tubes with Lid Lock

Cat. No.	Capacity (mL)	Color	Sterile	Qty. Per Box	Qty. Per Case
CFT010005	0.5	Natural	N	1000	8000
CFT010015	1.5	Natural	N	500	4000
CFT020015	1.5	Brown	N	500	4000
CFT010020	2.0	Natural	N	500	4000
CFT011005	0.5	Natural	Y	1000	8000
CFT011015	1.5	Natural	Y	500	4000
CFT021015	1.5	Brown	Y	500	4000
CFT011020	2.0	Natural	Y	500	4000

Black Micro Centrifuge Tubes with Lid Lock

Cat. No.	Capacity (mL)	Color	Sterile	Qty. Per Box	Qty. Per Case
CFT030005	0.5	Black	N	1000	8000
CFT030015	1.5	Black	N	500	4000
CFT030020	2.0	Black	N	500	4000
CFT031005	0.5	Black	Y	1000	8000
CFT031015	1.5	Black	Y	500	4000
CFT031020	2.0	Black	Y	500	4000

Micro Centrifuge Tubes with Lid Lock, Non-Sterile, 5 mL

Cat. No.	Capacity (mL)	Color	Sterile	Qty. Per Box	Qty. Per Case
CFT122050	5.0	Natural	N	200	4000
CFT123050	5.0	Blue	N	200	4000
CFT124050	5.0	Yellow	N	200	4000
CFT125050	5.0	Green	N	200	4000
CFT126050	5.0	Rose Red	N	200	4000
CFT127050	5.0	Black	N	200	4000
CFT110050	5.0	Yellow	N	250	2500
CFT112050	5.0	Black	N	250	2500

Micro Centrifuge Tubes with Lid Lock, Sterile, 5 mL

Cat. No.	Capacity (mL)	Color	Sterile	Qty. Per Box	Qty. Per Case
CFT322050	5.0	Natural	Y	200	4000
CFT323050	5.0	Blue	Y	200	4000
CFT324050	5.0	Yellow	Y	250	2500
CFT224050	5.0	Yellow	Y	200	4000
CFT325050	5.0	Green	Y	200	4000
CFT326050	5.0	Rose Red	Y	200	4000
CFT327050	5.0	Black	Y	200	4000
CFT210050	5.0	Yellow	Y	250	2500
CFT212050	5.0	Black	Y	250	2500

EasyFlip™ 1.5 mL Micro Centrifuge Tubes

The EasyFlip™ 1.5 mL micro centrifuge tubes are made of high-quality polymer polypropylene (PP). They are suitable for storage, operation and centrifugation of small amounts of samples, and may also be used with micropipettes for storage, operation and centrifugation of small amounts of liquid.

- Specification: 1.5 mL
- Materials: Polypropylene (PP), conforming to USP Class VI standards
- Bottom type: Conical
- Packaging: Bag (Box)



Features

- One-hand easy flip to open the cap
- Frosted body surface provides ease of marking and legibility
- Rigorously tested for leakage, excellent sealing performance
- Maximum RCF up to 25,000 ×g
- Temperature range: -80°C–121°C
- Sterilized and non-sterilized available, sterilized by irradiation to SAL 10⁻⁶
- DNase/RNase-free, non-pyrogenic

Cat. No.	Capacity (mL)	Sterile	Qty. Per Box	Qty. Per Case
CFT002015	1.5	N	500	4000
CFT003015	1.5	Y	500	4000



Low Binding Microcentrifuge Tubes

Lo-Protein™ Microcentrifuge Tubes

Lo-DNA™ Microcentrifuge Tubes

Gene therapy and vaccine production often involve various types of purification for proteins, DNA, and other substances. Since nonspecific binding to plastic containers will lead to the loss of valuable samples, the purification processes often depend on high-quality plastic products for sample processing and storage. The smaller the sample volume is, the more important it becomes to reduce the binding between the sample and the container used.

The low binding microcentrifuge tubes of JET BIOFIL is optimized for protein and DNA analytics. These tubes are made using a unique high-purity polypropylene polymer material that does not require any surface coating, such as silicization. Strict quality control is implemented in accordance with ISO9001 and ISO13485. The stable quality ensuring significantly reduces binding between samples and plastic surface, minimizing sample loss and achieving a maximum recovery rate of your precious samples and more accurate analysis results.

- Material: Polypropylene (PP), conforming to USP Class VI
- Capacity: 0.5 mL, 1.5 mL and 2.0 mL

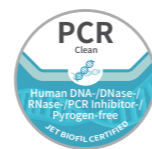

Features

- Made of special high-purity polypropylene (PP) polymer can effectively reduce the nonspecific binding of protein/nucleic acid to the tube surface.
- No surface coating (e.g., silicification) on the tube wall can reduce sample binding and interference to samples.
- Lid lock prevents accidental opening of cap and evaporation of samples during long-term storage, and ensures operating safety.
- Smooth and transparent tube body with clear graduation, designed with a frosted writing area, makes it convenient for recording.
- Samples of different proteins and nucleic acids can be ensured to the maximum recovery, with a recovery rate over 90%.
- The product has been tested for 18 items, including tightness, folding resistance of flipped cap, centrifugal force, solvent resistance, extractable and accelerated aging, which shows stable performance.
- The maximum centrifugal force for 1.5 mL, 2 mL is RCF 25,000 ×g; the maximum centrifugal force for 0.5 mL is RCF 30,000 ×g.
- Working temperature range: -80°C-121°C (no deformation after autoclaving with open lid)
- Sterilized and non-sterilized available, sterilized by irradiation to SAL 10⁻⁶
- DNase/RNase-free, Non-pyrogenic, human DNA-free, PCR inhibitor-free

Special Tips

- This product is not recommended for long-term sample storage for samples containing benzene, benzyl alcohol, or chloroform solvents.
- Re-autoclaving of sterilized low binding microcentrifuge tubes may result in yellowing of the materials but does not affect the usage for the products.
- The package can be removed and opened for autoclaving sterilization for one time. Repeated autoclaving sterilization is not recommended.

Cat. No.	Low Binding	Capacity (mL)	Maximum RCF (xg)	Sterile	Qty. Per Bag	Qty. Per Case
CFT800005	Protein	0.5	30,000	N	50	400
CFT060005	DNA	0.5	30,000	N	50	1200
CFT800015	Protein	1.5	25,000	N	50	400
CFT060015	DNA	1.5	25,000	N	50	1000
CFT800020	Protein	2.0	25,000	N	50	400
CFT060020	DNA	2.0	25,000	N	50	1000
CFT801005	Protein	0.5	30,000	Y	50	400
CFT061005	DNA	0.5	30,000	Y	50	1200
CFT801015	Protein	1.5	25,000	Y	50	400
CFT061015	DNA	1.5	25,000	Y	50	1000
CFT801020	Protein	2.0	25,000	Y	50	400
CFT061020	DNA	2.0	25,000	Y	50	1000

Deep-well Plates

As a commonly used lab consumable, the deep-well plate is generally used for DNA detection, high-throughput reactions, storage and transfer of samples, and antibody titer detections. It has become popular in recent years as one of the main consumables for nucleic acid testing. Our deep-well plate is made of the polymer polypropylene (PP). Thanks to its excellent chemical compatibility, it can be used for a variety of laboratory reagents such as polar organic solutions, as well as acidic and alkaline solutions. Its appearance also conforms to SBS standards. The product can be used with a variety of automation instruments. In particular, the 96-round-well plates (1 mL) can be used in combination with the magnetic bead kits.

- Number of wells: 48 or 96 wells
- Well shape: Round and square types
- Well bottom shape: U-shaped and V-shaped
- Volume: 96-well: 0.36 mL, 0.4 mL, 1.0 mL, 1.6 mL, 2.0 mL and 2.2 mL
48-well: 3.5 mL and 4.6 mL
- Materials: Polypropylene (PP), conforming to USP Class VI standards

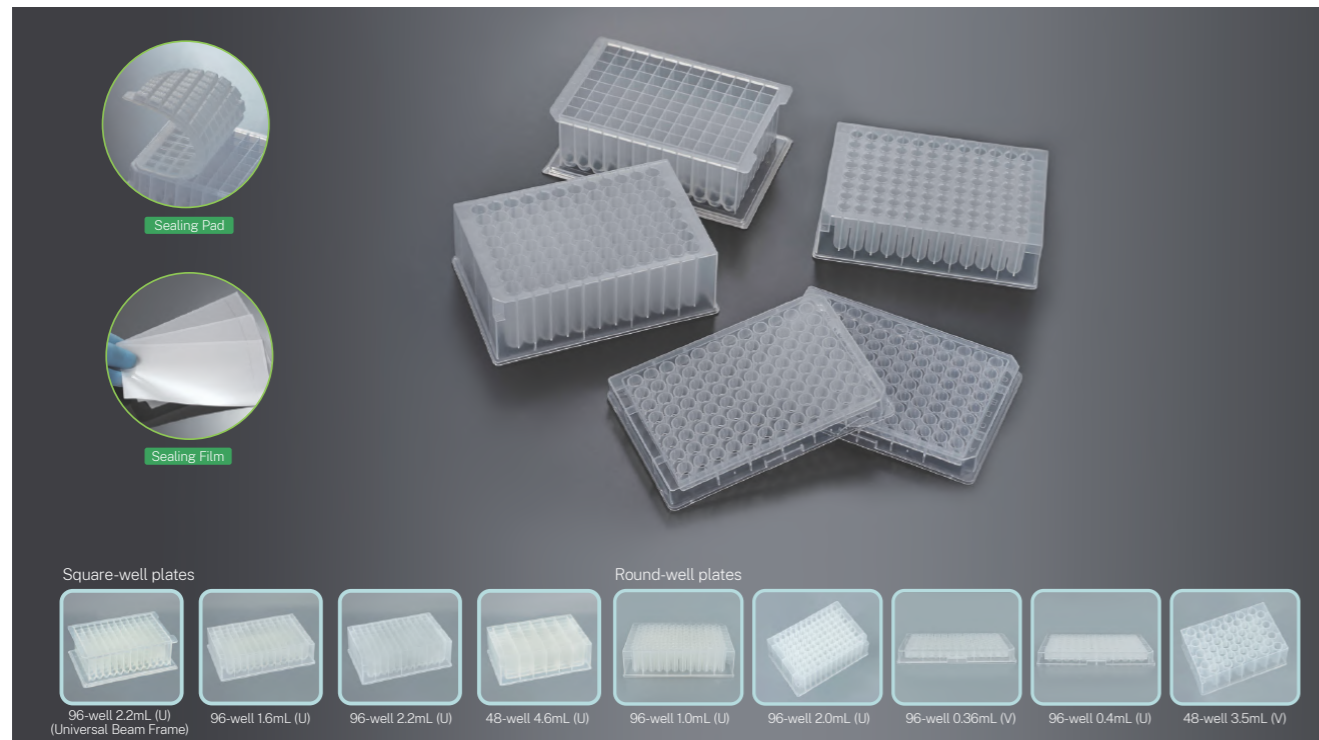

Features

- Stable chemical performance, excellent resistance to chemical corrosion and to high temperatures and pressure
- Even thickness of plate bottom and side walls; smooth plate, no liquid leakage; uniform well diameter
- Alphanumeric markings on the plate and chamfered corners to facilitate identification and operation
- The 96-well deep-well plate can be sealed using either a sealing membrane or a silicone pad
- Maximum RCF 3,000 ×g, with no damage or deformation
- Temperature range: -80°C-121°C
- Sterilized and non-sterilized available, sterilized by irradiation to SAL 10⁻⁶
- DNase/RNase-free, non-pyrogenic

Sample storage

This product can replace the conventional 1.5 mL centrifuge tube for sample storage. It provides outstanding space savings, a large storage volume and a tidy arrangement, and is also suitable for refrigeration down to -80°C, hence it is also called a storage plate.

Sample treatment

Supports high-throughput operation of biological samples by working together with multichannel micropipettes and high-throughput automated liquid handling systems. This includes protein precipitation, liquid dispensing, and nucleic acid extraction, dramatically improving sample treatment efficiency.

Sample handling

Suitable for use with various kinds of automation equipment; can be used for handling samples directly. In comparison to traditional sample handling methods, it increases sample quantity inside the sample chamber by a factor of 2, while also enabling direct sample handling after treatment in the 96-well plate. That reduces the overall workload for back-and-forth sample operations.

96-well Plate

Cat. No.	Capacity (mL)	Qty.well	Bottom	Bottom Shape	Lid	Sterile	Qty. Per Bag	Qty. Per Case
VWP032096	0.36	96	Round	V Shape	N	N	10	100
VWP033096	0.36	96	Round	V Shape	N	Y	10	100
VWP033196	0.36	96	Round	V Shape	Y	Y	10	100
UWP042096	0.4	96	Round	U Shape	N	N	10	100
UWP043096	0.4	96	Round	U Shape	N	Y	10	100
RWP103296	1.0	96	Round	U Shape	N	Y	5	50
RWP102596	1.0	96	Round	U Shape	Y	N	5	50
RWP103596	1.0	96	Round	U Shape	Y	Y	5	50
RWP203296	2.0	96	Round	U Shape	N	Y	5	50
RWP202596	2.0	96	Round	U Shape	Y	N	5	50
RWP203596	2.0	96	Round	U Shape	Y	Y	5	50
DMP160096	1.6	96	Square	U Shape	N	N	1	50
DMP161096	1.6	96	Square	U Shape	N	Y	1	50
DMP160196	1.6	96	Square	U Shape	Y	N	1	50
DMP161196	1.6	96	Square	U Shape	Y	Y	1	50
DMP220096	2.2	96	Square	U Shape	N	N	1	50
DMP221096	2.2	96	Square	U Shape	N	Y	1	50
DMP220196	2.2	96	Square	U Shape	Y	N	1	50
DMP221196	2.2	96	Square	U Shape	Y	Y	1	50
DMP223296	2.2	96	Square(With UB frame)	U Shape	N	Y	5	50

48-well Plate

Cat. No.	Capacity (mL)	Qty. Well	Bottom	Bottom Shape	Lid	Sterile	Qty. Per Bag	Qty. Per Case
RWP352048	3.5	48	Round	V Shape	N	N	24	96
RWP353248	3.5	48	Round	V Shape	N	Y	5	50
RWP352548	3.5	48	Round	V Shape	Y	N	5	50
RWP353548	3.5	48	Round	V Shape	Y	Y	5	50
DMP462048	4.6	48	Square	U Shape	N	N	24	96
DMP463248	4.6	48	Square	U Shape	N	Y	5	50

Sealing Film

Cat. No.	Description	Specification	Sterile	Qty. Per Bag	Qty. Per Case
DMP010096	For all Deep-well plates	L143×W87×0.4mm	N	50	1000
DMP011096	For all Deep-well plates	L143×W87×0.4mm	Y	100	1000

Sealing Pad

Cat. No.	Description	Sterile	Qty. Per Bag	Qty. Per Case
DMP020096	For all 96-well plates (Square Only)	N	50	100
DMP021096	For all 96-well plates (Square Only)	Y	50	100

Sample Library Tubes

The sample library tubes are disposable consumable products specially designed for long-term storage of samples. They display excellent chemical stability and sealing performance, and are suitable for long-term storage and low-temperature cryopreservation of samples such as serum, cells and tissues.

- Specifications: 1.2 mL, single 8-strip tube 12-strip tube
- Materials: Tube body: Polypropylene (PP) Tube Cap: Polyethylene (PE) Tube Rack: Polypropylene (PP) Conforming to USP Class VI standards

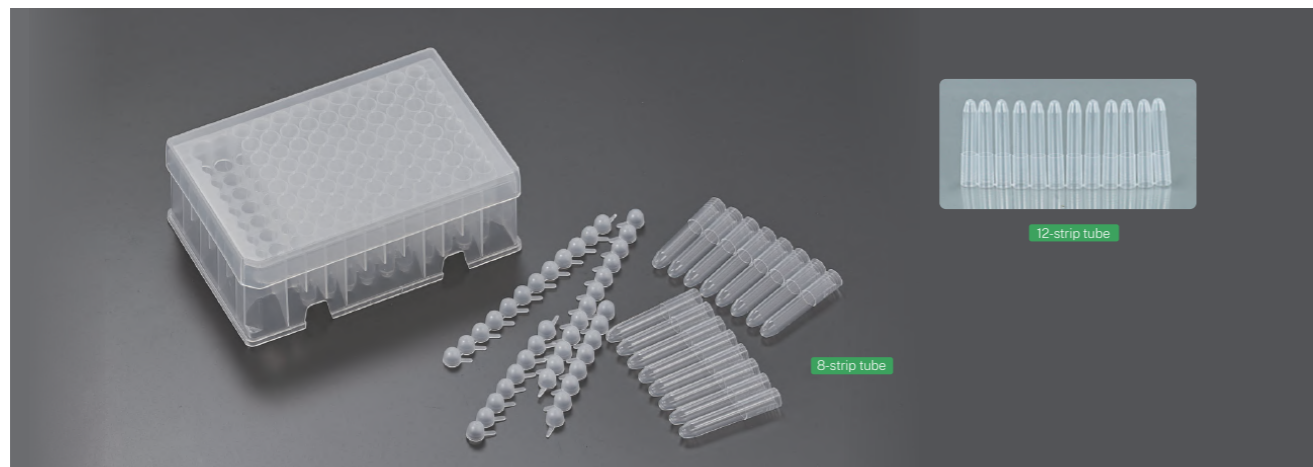

Features

- The tube body is made of transparent polypropylene with stable chemical properties
- Uniform wall thickness, smooth and transparent surface, easy to observe and operate
- Single, 8-strip tube, 12-strip tube and other specifications available with or without cap to meet different experimental needs
- Clear alphabetical sequence and chamfered corners for easy identification, observation and manipulation of samples during collection and storage
- Temperature range: -80°C-121°C
- Sterilized and non-sterilized available sterilized by irradiation to SAL 10⁻⁶
- DNase/RNase-free, non-pyrogenic

Cat. No.	Capacity (mL)	Sterile	Description	Package	Qty. Per Bag (Rack)	Qty. Per Case
TUC000012	1.2	N	8-strip tube cap	Re-sealable bag	125	1250
TUC000013	1.2	Y	8-strip tube cap	Re-sealable bag	125	1250
TUC000014	1.2	N	12-strip tube cap	Re-sealable bag	80	800
TUC000015	1.2	Y	12-strip tube cap	Re-sealable bag	80	800

Cat. No.	Capacity (mL)	Sterile	Description	Package	Qty. Per Bag (Rack)	Qty. Per Case
TUB000012	1.2	N	8-strip tube	Re-sealable bag	125	1250
TUB001012	1.2	N	12-strip tube	Re-sealable bag	80	800
TUB002012	1.2	N	Individual tube	Re-sealable bag	1000	10000
TUB003012	1.2	N	Individual tube	Rack	960	9600
TUB004012	1.2	Y	Individual tube	Rack	960	9600
TUB005012	1.2	N	8-strip tube	Rack	960	9600
TUB006012	1.2	Y	8-strip tube	Rack	960	9600
TUB007012	1.2	N	12-strip tube	Rack	960	9600
TUB008012	1.2	Y	12-strip tube	Rack	960	9600

Premium PCR Consumables Series

PCR Plates

The PCR plate is the carrier of an amplification reaction system in Polymerase Chain Reaction (PCR) experiments, which is widely used in genetics, biochemistry, immunology, medicine and other fields. The raw materials of the Jet Biofil PCR plates conform to USP Class VI standards. The plate surface is flat, firm and not easy to deform. The thin wall design of the tube body features good thermal conductivity and ensures high-efficiency PCR reaction.

- Specification: 96-well non-skirted, 96-well semi-skirted, 96-well agree fully skirted
- Capacity: 0.2 mL/well
- Color: Transparent, white
- Material: Polypropylene (PP), conforming to USP Class VI standards

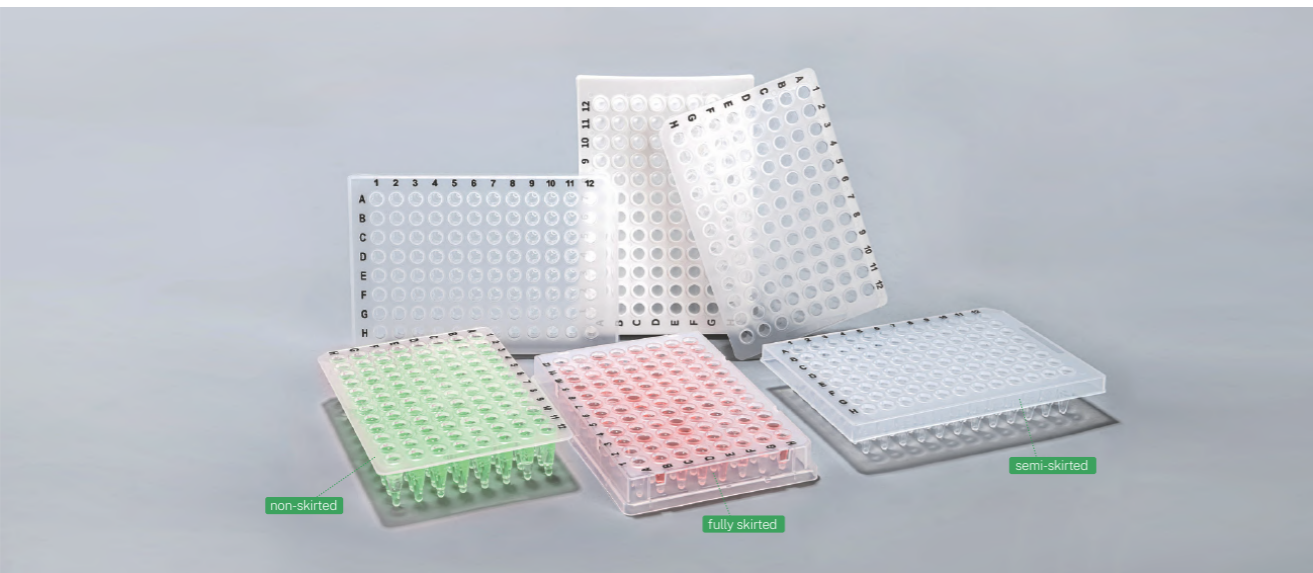

Features

- Thin tube wall design, uniform thickness, rapid and uniform heat transfer, reliable results and strong repeatability.
- The plate surface is flat and firm, resistant to warping, and remains reliable and non-deformable in automated, high temperature and high pressure (121°C, 20 min) processes, high-speed centrifugation (2000 ×g) and other operations.
- The edge of the wells protrude to prevent cross-contamination and to facilitate sealing, which can effectively reduce the evaporation of samples after sealing.
- Black letter markings to help quickly identify and trace samples when manually adding samples.
- Transparent and white plates are available. The white PCR plate is good for reading low-signal fluorescence values, reduce background fluorescence interference, and are more suitable for qPCR experiments.
- The plate type conforms to SBS/ANSI international standards; high adaptability and compatible with many mainstream brands of PCR/qPCR instruments.
- Each well is tested for 100% leak tightness to ensure safe sample handling.
- Human-derived DNA-free, DNase/RNase-free, pyrogen-free, PCR inhibitor-free, ATP-free.

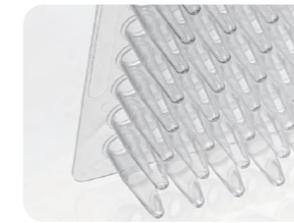

Thin tube wall design, uniform thickness



The edge of the wells is protruding to prevent cross-contamination and to facilitate sealing

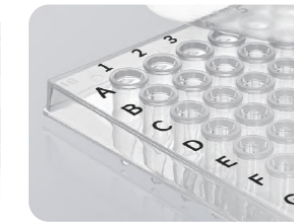

Black letter marking



White PCR plate

Cat. No.	Capacity (mL)	Specification (Well)	Skirted	Color	Sterile	Qty. Per Box	Qty. Per Case
PCR400096	0.2	96	Non-skirted	Transparent	N	10	100
PCR410096	0.2	96	Semi-skirted	Transparent	N	10	100
PCR420096	0.2	96	Fully skirted	Transparent	N	10	100
PCR401096	0.2	96	Non-skirted	Transparent	Y	10	100
PCR411096	0.2	96	Semi-skirted	Transparent	Y	10	100
PCR421096	0.2	96	Fully skirted	Transparent	Y	10	100
PCR500096	0.2	96	Non-skirted	White	Y	10	100
PCR510096	0.2	96	Semi-skirted	White	Y	10	100
PCR520096	0.2	96	Fully skirted	White	Y	10	100

PCR Tubes

The disposable PCR tube of JET BIOFIL, with a capacity of 0.2 mL, is made of polypropylene (PP) conforming to USP Class VI standards. When used as the carrier of a PCR amplification system, it can repeatedly withstand high and low temperatures. For low-and medium-throughput PCR/qPCR experiments, the disposable PCR tube is an ideal solution.

- Specification: 8-tube strip, single-tube
- Color: Transparent, white
- Material: Polypropylene (PP), conforming to USP Class VI standards



Features

- Thin tube wall design, uniform thickness, rapid and uniform heat transfer, reliable results and strong repeatability.
- Support high-RCF centrifugation (10000 ×g), autoclave sterilization (121°C, 20 min) and other operations.
- The tube cap fits perfectly with the body, ensuring a strong sealing performance. This effectively reduces the evaporation rate.
- Different markings at the head and end of the joint cap for easy identification of direction.
- Transparent and white tubes are available. The white PCR tube is good for reading low-signal fluorescence values and reduces background fluorescence interference, and is more suitable for qPCR experiments.
- DNase/RNase-free, human-derived DNA-free, PCR inhibitor-free, ATP-free, pyrogen-free.



Thin tube wall design, uniform thickness



The tube cap is well matched with the body, good sealing



Different marks at the head and end of the joint cap for easy identification of direction



White PCR tubes

Cat. No.	Description	Color	Sterile	Qty. Per Bag	Qty. Per Case
PCR410200	0.2mL PCR Tubes with Flat Cap, Single	Transparent	N	1000	10000
PCR420200	0.2mL PCR Tubes with Flat Cap, 8 Strips	Transparent	N	125	1250
PCR411200	0.2mL PCR Tubes with Flat Cap, Single	Transparent	Y	1000	10000
PCR421200	0.2mL PCR Tubes with Flat Cap, 8 Strips	Transparent	Y	125	1250
PCR520200	0.2mL PCR Tubes with Flat Cap, 8 Strips	White	Y	125	1250
PCR620200	0.2mL PCR Tubes with Flat Cap, 8 Strips	Transparent	N	125	1250
PCR621200	0.2mL PCR Tubes with Flat Cap, 8 Strips	Transparent	Y	125	1250

PCR Plate Sealing Film

JET BIOFIL's PCR plate sealing film can be used for routine 96-well PCR experiment, qPCR experiment, sample storage, etc.. Two types of common PCR microplate sealers and qPCR microplate sealers are available.

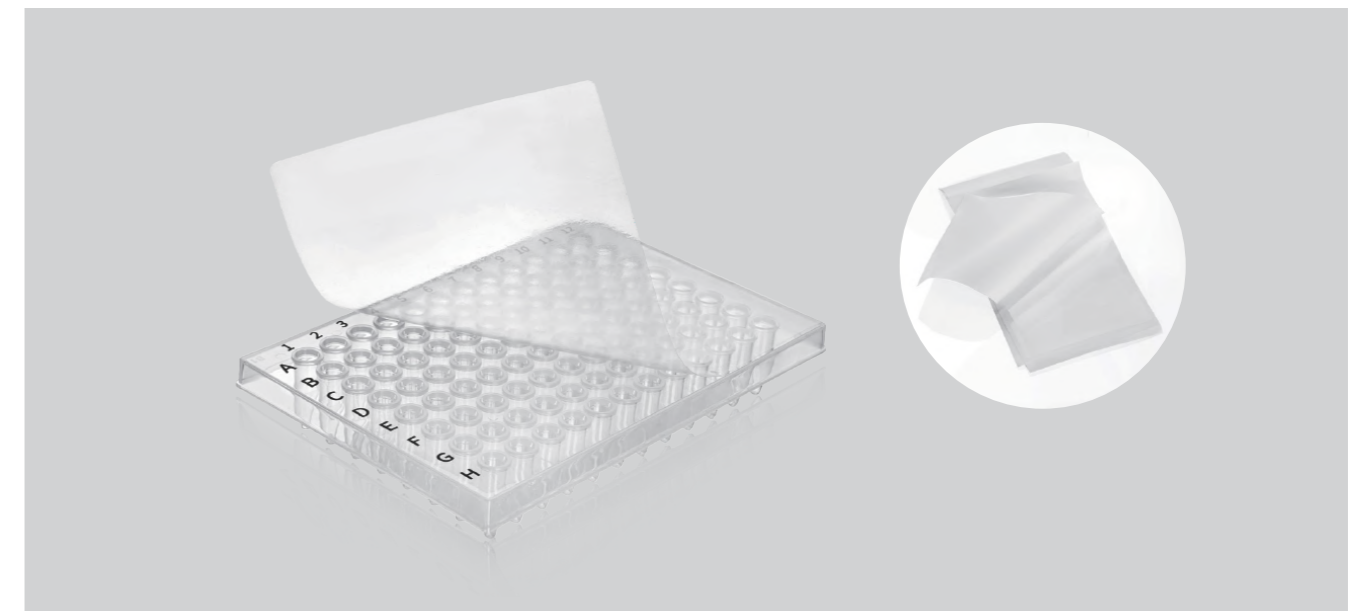

Common PCR Plate Sealing Film:

Material: composed of PP material conforming to USP Class VI standard in the upper layer and medical grade adhesive in the lower layer

Thickness of sealing film: 50 μm

Temperature tolerance range: -80°C to 121°C

- Economical and easy to use, suitable for mainstream PCR plates
- Good sealing, low evaporation, prevents cross-contamination of samples between wells

qPCR Plate Sealing Film:

Material: The qPCR plate sealing film is composed of a layer of high-transparency PP sealer conforming to USP Class VI standard and medical grade adhesive

Thickness of adhesive sealer: 50 μm

Temperature tolerance range: -80°C to 121°C

- Innovative adhesives ensure a safe seal without sticking to skin and gloves
- Good sealing, low evaporation, prevents cross-contamination of samples between wells
- No autofluorescence, suitable for fluorescent quantitative PCR

Cat. No.	Type	Specification (length mm * width mm)	Sterile	Qty. Per Box	Qty. Per Case
PCR400001	PCR	137.5*82	N	100	1000
PCR401001	PCR	137.5*82	Y	100	1000
PCR400003	qPCR	140*80	N	100	1000
PCR401003	qPCR	140*80	Y	100	1000

Recommended storage conditions: 10°C-27°C, 40%-60% relative humidity

Reagent Reservoirs (PP)

The reagent reservoirs are made of transparent polypropylene (PP) for good chemical compatibility. They support both automated and manual operations. A variety of specifications are available, all of which meet the requirements of ANSI/SLAS 1-2004 microplate dimensions, and compatible with most automated systems.

- ◎ Specifications: 15 mL, 22 mL, 185 mL and 195 mL
- ◎ Material: Polypropylene (PP), conforming to USP Class VI standards



Features

- ◎ Multiple capacities and well configurations are available for different experimental needs
- ◎ Rhombic well series: 96-or 384-well reagent reservoirs at the bottom, helping to minimize dead space volume
- ◎ Multi-channel reagent reservoirs are suitable for both 8-channel and 12-channel pipettes
- ◎ Uniform wall thickness and smooth, transparent surface for convenient observation and operation
- ◎ Product dimensions conform to SBS standards; highly adaptable and compatible with most of automated systems
- ◎ Treated by an electrostatic process and other techniques, no residue or wall clinging, minimizing liquid residue
- ◎ Sterilized and non-sterilized available, sterilized by irradiation to SAL 10⁻⁶
- ◎ DNase/RNase-free, non-pyrogenic

Cat. No.	Well Capacity (mL)	Total Capacity (mL)	Lid	Number of Wells	Sterile	Qty. Per Box	Qty. Per Case
RES082022	22	-	N	8	N	10	50
RES083022	22	-	N	8	Y	10	50
RES122015	15	-	N	12	N	10	50
RES123015	15	-	N	12	Y	10	50
RES962095	-	195	N	96	N	10	50
RES963095	-	195	N	96	Y	10	50
RES842085	-	185	N	384	N	10	50
RES843085	-	185	N	384	Y	10	50

Reagent Reservoirs (PET / PS)

The Reagent Reservoirs (PET/PS) are mainly used for holding transferred reagents in cases where the same liquid may need to be transferred several times during the process. In particular, when a multi-channel pipettes or liquid-transferring instrument is used, the process becomes easier when liquids are placed in the liquid transfer trough. This trough produced by JET BIOFIL will remain stable and leave fewer residues. Users can easily remove liquids from multi-channel pipettes.

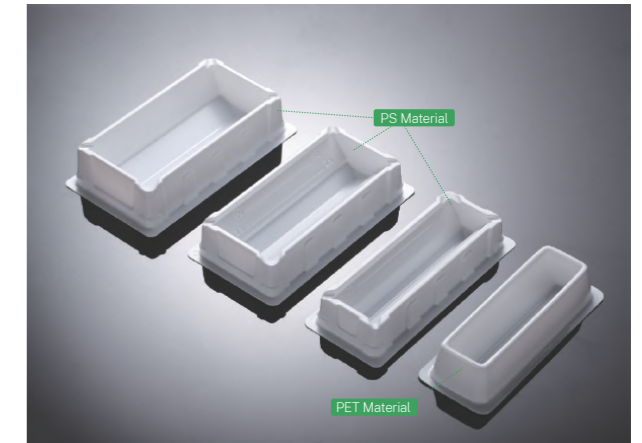

- ◎ Specification: 25 mL 50 mL 100 mL
- ◎ Material: Polyethylene terephthalate(PET)/polystyrene (PS), conforming to USP Class VI standards

Features

- ◎ Made of high-quality PET/PS with excellent chemical stability
- ◎ Available in various specifications; suitable for use with multi-channel pipettes
- ◎ Clean and smooth surfaces
- ◎ Slightly tilted inner surface, which helps to reduce residue
- ◎ Sterilized by irradiation, SAL 10⁻⁶
- ◎ DNase/RNase-free, non-pyrogenic

Cat. No.	Capacity (mL)	Color	Sterile	Material	Qty. Per Bag	Qty. Per Case
LTT012025	25	White	Y	PS	1	50
LTT052025	25		Y	PS	5	100
LTT002025	25		N	PS	100	100
LTT012050	50		Y	PS	1	50
LTT052050	50		Y	PS	5	100
LTT002050	50		N	PS	100	100
LTT000050	50		N	PET	20	400
LTT001050	50		Y	PET	20	400
LTT010050	50		N	PET	1	1/80
LTT011050	50		Y	PET	1	1/80
LTT012100	100	Y	PS	1	1/50	
LTT052100	100	Y	PS	5	100	
LTT002100	100	N	PS	100	100	

12-Channel Reagent Reservoirs

The 12-channel reagent reservoirs are mainly used for pipetting reagents. It is necessary to repeatedly pipette liquids in pipetting, serial dilution, and other operations. Especially when using multi-channel pipettes, it's easier to pipette if the liquid is placed in a reservoir. JET BIOFIL's 12-channel reagent reservoirs honor smooth tabletop stability and little residue, making it convenient for users to realize quick and continuous pipetting operations with multi-channel pipettes.

◎ Material: Polypropylene (PP), Conforming to USP Class VI standards



Features

- ◎ Made of high-quality polypropylene raw materials, transparent and visible, with little liquid residue and strong chemical corrosion resistance, suitable for the storage of most polar organic solutions, acidic and alkaline solutions
- ◎ Overall rectangular structure, with widened bottom edge and good stability on table surface
- ◎ 12-channel design, with each channel holding 3 mL, which facilitates continuous dilution or pipetting of different liquids at the same time
- ◎ Each channel is numbered for easy identification
- ◎ The inclined wall and V-shaped bottom design make sample recovery easy
- ◎ Equipped with an upper cover, which closely fits the reservoirs and can effectively reduce evaporation and contamination during incubation and storage
- ◎ Suitable for multi-channel pipettes of most brands
- ◎ Each product has a separate, easy-to-tear PE bag
- ◎ Working temperature range: -80°C ~ 121°C
- ◎ Sterilized and non-sterilized available, sterilized by irradiation to SAL 10⁻⁶
- ◎ DNase/RNase-free, non-pyrogenic

Cat. No.	Capacity(mL)	L×W×H (mm)	Cover	Sterile	Color	Qty. Per Box/ Case
LTT011012	3×12	127.6×57.7×26.4	Y	Y	Transparent	1/50
LTT001012	3×12	127.6×57.7×26.4	Y	N		1/50
LTT012012	3×12	127.6×57.7×26.4	Y	Y		1/240
LTT002012	3×12	127.6×57.7×26.4	Y	N		1/240



CellSafe™ GMP-grade Life Science Consumables



Biomedicine is booming, and it is urgent to improve the cleanliness grade of consumables

China's biomedical industry has entered a stage of rapid development, including antibodies, vaccines, recombinant proteins, cell therapy, gene therapy, etc. The approval policy for biomedicines has gradually become in line with international standards, and relevant policies, regulations and guiding principles have been rapidly rolled out in recent years. The quality requirements of consumables related to biological products are becoming increasingly stricter, including for functional applicability research, biosafety research and biocompatibility research. Therefore, it is urgent to improve the cleanliness grade of consumables for biological laboratories.

Rapid advancement, rush into the future GMP-grade life science consumables of JET BIOFIL are coming!

By mastering a number of key core technologies and advanced production processes for international leading biological laboratory consumables, JET BIOFIL has been committed to creative solutions to provide higher quality biotechnology research and development tools for more than 20 years. The CellSafe™ series of GMP-grade life science consumables can meet the requirements of biopharmaceutical companies and other clean laboratories for biological experimental consumables of higher cleanliness levels for standard manufacturing and large-scale production of cell therapies, gene therapies, antibodies and vaccines.

CellSafe™ GMP-grade Life Science Consumables

JET BIOFIL is always committed to providing you with higher quality products. The CellSafe™ series GMP-grade bioscience consumables are manufactured in strict accordance with GMP standards, with high cleanliness, high safety, and medical triple bagged packaging, which can meet the needs of biopharmaceutical companies or other clean laboratories for biological laboratory consumables of higher cleanliness levels for cell therapies, gene therapies, antibodies and vaccines.

- Products: Serological pipets, centrifuge tubes, conical centrifuge bottles, cell and tissue culture flasks, cell and tissue culture plates, cell and tissue culture dishes, cell factories, Erlenmeyer flasks, etc.
- Packaging: Triple-bagged packaging for medical use



Features

- ISO 13485 (medical device quality management system) and ISO 9001 certified
- Produced in Class 100,000 (partially Class 10,000) GMP cleanrooms with a fully automatic production process
- U.S. FDA registered company (registration No.: 3011966385) and obtained the EU CE record
- Made with USP Class VI standards medical-grade raw materials
- CNAS-certified laboratory; finished products are authoritatively tested by third-party testing institutions
- Independent three-layer medical outer packaging, which can be easily removed layer by layer, and is safe and convenient to use
- The smallest bag of each product is marked with the batch number, which is easy for quality traceability
- Sterilized by irradiation, SAL 10⁻⁶
- DNase/RNase-free, pyrogen-free, non-cytotoxic

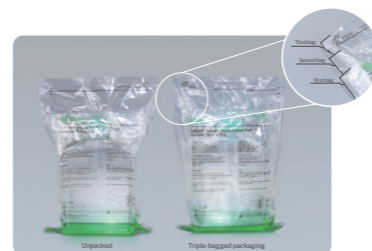

CellSafe™ Serological Pipets

	Cat. No.	Volume(mL)	Scale (mL)	Color code	Packaging	Sterile	Qty. Per Bag	Qty. Per Case
	CSP010005	5	1/10	Blue	Triple-bagged packaging	Y	10	200
	CSP013010	10 (Stretch)	1/10	Orange	Triple-bagged packaging	Y	10	200
	CSP010010	10	1/10	Orange	Triple-bagged packaging	Y	10	200
	CSP010025	25	2/10	Red	Triple-bagged packaging	Y	10	150
	CSP010050	50	5/10	Purple	Triple-bagged packaging	Y	10	100

CellSafe™ Centrifuge Tubes

	Cat. No.	Volume (mL)	Bottom	Maximum RCF (xg)	Packaging	Sterile	Qty. Per Bag	Qty. Per Case
	CSP020015	15	Conical	12000	Triple-bagged packaging	Y	25	500
	CSP020050	50	Conical	12000	Triple-bagged packaging	Y	25	500

CellSafe™ Conical Centrifuge Bottles

	Cat. No.	Volume (mL)	Bottom	Maximum RCF (xg)	Packaging	Sterile	Qty. Per Bag	Qty. Per Case
	CSP020250	250	Conical	7500	Triple-bagged packaging	Y	6	48
	CSP020500	500	Conical	6000	Triple-bagged packaging	Y	6	36

CellSafe™ Cell and Tissue Culture Flasks

	Cat. No.	Volume (mL)	Cell culture surface area (cm ²)	Surface	Packaging	Sterile	Qty. Per Bag	Qty. Per Case
	CSP031250	250	75	TC-treated	Triple-bagged packaging	Y	1	40
	CSP031600	600	182	TC-treated	Triple-bagged packaging	Y	1	40
	CSP031225	850	225	TC-treated	Triple-bagged packaging	Y	1	24

CellSafe™ Cell and Tissue Culture Plates

	Cat. No.	Specification (well)	Well type	Recommended working volume of a single well (mL)	Packaging	Sterile	Qty. Per Bag	Qty. Per Case
	CSP040006	6	Flat bottom	1.9-2.9	Triple-bagged packaging	Y	10	100
	CSP040096	96	Flat bottom	0.0075-0.2	Triple-bagged packaging	Y	10	100

CellSafe™ Cell and Tissue Culture Dishes

	Cat. No.	Surface	Diameter (mm)	Height (mm)	Recommended working volume (mL)	Packaging	Sterile	Qty. Per Bag	Qty. Per Case
	CSP050150	TC-treated	150	22	25-50	Triple-bagged packaging	Y	1	120

CellSafe™ CellFac® Multi-Layer Cell Culture Systems

	Cat. No.	Type	Surface area (cm ²)	Working volume (mL)	Surface	Packaging	Sterile	Qty. Per Bag	Qty. Per Case
	CSP060005	5-layer	3216	650-1000	TC-treated	Triple-bagged packaging	Y	1	4
	CSP060010	10-layer	6416	1300-2000	TC-treated	Triple-bagged packaging	Y	1	2

CellSafe™ Erlenmeyer Flasks

	Cat. No.	Volume (mL)	Flask material	Cap	Packaging	Sterile	Qty. Per Bag	Qty. Per Case
	CSP070125	125	PC	Vent	Triple-bagged packaging	Y	1	24
	CSP070250	250	PC	Vent	Triple-bagged packaging	Y	1	12
	CSP070500	500	PC	Vent	Triple-bagged packaging	Y	1	12
	CSP070000	1000	PC	Vent	Triple-bagged packaging	Y	1	12

CellSafe™ Vacuum Bottle Filters

	Cat. No.	Membrane Material	Pore Size (µm)	Volume (mL)	Membrane Diameter (mm)	Packaging	Sterile	Qty. Per Bag	Qty. Per Case
	CSP080500	PES	0.22	500	500	Triple bagged packaging	Y	1	12
	CSP081500	PES	0.45	500	500	Triple bagged packaging	Y	1	12
	CSP080000	PES	0.22	1000	1000	Triple bagged packaging	Y	1	12
	CSP081000	PES	0.45	1000	1000	Triple bagged packaging	Y	1	12

CellSafe™ Peripheral Blood Separation Tube

The JET BIOFIL CellSafe™ PBMC Separation Tube boasts a unique design featuring a built-in separation bracket, which effectively reduces the mixing of target samples and the density gradient medium during the centrifugation process. This design allows Mononuclear Cells (MNCs) to be retained above the separation bracket, separating them from the red blood cells and granulocyte layer present at the tube's bottom. MNCs can be effortlessly collected without the need for complex steps, streamlining experiments and saving valuable time compared to traditional methods.

CellSafe™ PBMC Separation Tube strictly adheres to the Good Manufacturing Practice (GMP) standards. It meets the requirements for biological laboratory consumables with a higher cleanliness grade, ensuring its suitability for various experimental applications.

- Specification: 50 mL with separation bracket
- Bottom Type: Conical
- Material: Tube Body: Polypropylene (PP) \ Tube Cap: High-density polyethylene (HDPE) \ Separation Bracket: Methyl methacrylate-butadiene-styrene (MBS) All materials conform to USP Class VI standards.
- Cap Type: Flat
- Separation Bracket Type: Eight-hole Cylindrical



Features

- The built-in separation bracket minimizes the mixing of the sample and the separation medium, thereby avoiding the need for slow and laborious application of the sample to the upper layer of the density gradient medium ①
- Easy to operate, with MNCs collected by directly pouring out after centrifugation
- High consistency minimizes the influence of human operation on experimental outcomes
- Rapidly isolates peripheral blood mononuclear cells (PBMCs) within a 15-minute time frame
- The CellSafe™ PBMC Separation Tube is manufactured in strict adherence to GMP standards, and the finished items undergo rigorous third-party testing to meet the experimental requirements for consumables with a higher cleanliness grade
- Triple independent bagged clean medical outer packaging, with product lot number marked on the innermost layer for traceability ②
- Sterilized by irradiation, SAL 10⁻⁶
- DNase/RNase-free, non-pyrogenic, non-cytotoxic and no mycoplasma

Cat. No.	Description	Sterile	Recommended Sample Volume		Qty. Per Bag	Qty. Per Case
			Undiluted	Diluted		
CSP021050	Tube with separation scaffold (50 mL/tube)	Y	4-17mL	15-30mL	25	100

Operation Method



Equilibrate the temperature of the separation medium to room temperature in advance and keep it away from light.

1



Pipette 15 mL of separation medium through the central hole of the separation bracket. The top of the separation medium should be above the separation bracket. (For large treatment capacity, centrifugation at 1000 \times g for 1 min at room temperature following the addition of medium is also acceptable.)

2

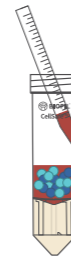

Pipette the blood sample down the side of the tube (the sample can also be poured down the side of the tube, but should be kept from directly entering the separation medium below the separation scaffold through the central hole). Blood samples should be anticoagulated whole blood (diluted if necessary).

3

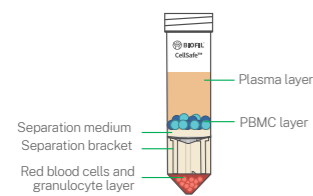

Centrifuge at 1200 \times g for 10 min at room temperature, with the brake on (following centrifugation, the liquid is stratified from top to bottom as plasma layer, PBMC layer, separation medium, separation bracket, and red blood cells and granulocyte layer).

4

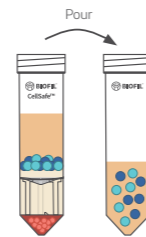

Pour off the top layer containing PBMCs and plasma into a new clean centrifuge tube or pipette out the PBMC layer.

5

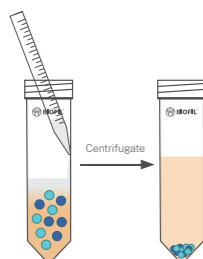

Wash the collected PBMCs with phosphate buffered saline (PBS) and centrifuge at 250 \times g for 10 min at room temperature.

6

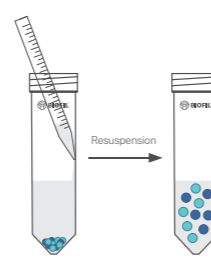

Wash 2 times, and then resuspend the collected PBMCs with PBS buffer or suitable media for later use.

7



— Stock Code: 688026 —

In Vitro Fertilization (IVF) Products

Specialized Consumables for Assisted Reproduction (Medical Device)



In vitro fertilization (IVF) refers to the process of taking sperm and eggs out of the body and completing the fertilization process in an artificially controlled environment. The early embryos cultured in vitro can be implanted into the human body, giving birth to new life.

IVF technology involves many details, and the entire process requires a significant investment of time, effort, and financial resources. The choice of consumables used in the IVF process is a crucial aspect with strict product quality requirements.

Jet Biofil's Specialized Consumables for Assisted Reproduction are designed to provide safe and reliable products for complex IVF applications. Through rigorous testing, including authoritative third-party biocompatibility inspection, in vitro mouse embryo experiments, and human sperm survival tests, ensuring the vitality of human reproductive cells and embryos throughout the complex processes of preparation, storage, operation, cultivation, and transfer in an in vitro environment. All products strictly adhere to ISO 13485 for rigorous production and quality control, also following the GMP manufacturing requirements to ensure even more stable and reliable product quality.

Specialized Consumables for Assisted Reproduction (Medical Device)

Registration Certificate No.: GDMDR 20232181838

In vitro fertilization (IVF) refers to the process of taking sperm and eggs out of the body and fertilizing egg with sperm in vitro in an artificially controlled environment. JET BIOFIL specialized consumables for assisted reproduction are designed to provide safe and reliable products for complex IVF and other assisted reproductive applications. These consumables undergo rigorous third-party testing, including biocompatibility, in vitro mouse embryo, and human sperm survival tests to ensure that human germ cells and embryos remain viable throughout the process of preparation, storage, operation, culture, and transfer in an in vitro environment.

- Model: Center-well Culture Dish, 35/60/90mm Culture Dish (Flat Bottom), Four-well Culture Plate
- Material: polystyrene (PS), conforming to USP Class VI standards



Features

- Selecting medical-grade polystyrene as the preferred raw material for its highly transparent surface that facilitates the observation of eggs and embryos
- Smooth and thin bottom design for efficient heat transfer and constant temperature and pH
- Designed lid to facilitate aseptic operation and maintain a stable environment for embryo culture over long periods
- Gear ring design on the dish side for easy hold and use to effectively reduce the risk of contamination
- Surface without TC treatment for optimum consistency of media droplets
- Conducting rigorous third-party testing to ensure non-embryotoxic, non-pyrogenic, non-cytotoxic, non-genotoxic, or non-mutagenic
- Implementing strict production and quality testing controls as per ISO 13485 and relevant GMP requirements to ensure stable and reliable product quality
- Sterilized by irradiation, SAL 10⁶

1



IVF-Specialized Center-well Culture Dish

- ◇ Size: 50.4×13.8 mm (dish); 21×14 mm (well)
- ◇ Purpose: Thawing frozen embryos to restore their biological activity; in vitro culture of embryos

2



IVF-Specialized 35 mm Culture Dish

- ◇ Size: 33×10.5 mm (dish); 36×6 mm (lid)
- ◇ Purpose: Droplet culture of embryos

3



IVF-Specialized 60 mm Culture Dish

- ◇ Size: 52.5×15 mm (dish); 55.5×6 mm (lid)
- ◇ Purpose: Egg collection, washing, and digestion of granular cells outside the egg; embryo freezing/thawing

4



IVF-Specialized 90 mm Culture Dish

- ◇ Size: 85×14.5 mm (dish); 89×8 mm (lid)
- ◇ Purpose: Egg collection, washing, and digestion of granular cells outside the egg

5



IVF-Specialized Four-well Culture Plate

- ◇ Size: 16×12 mm (single well)
- ◇ Purpose: Freezing and recovery of embryos and in vitro culture of embryos

Cat. No.	Model	Description	Surface Type	Sterile	Qty. Per Bag (Box)	Qty./Case
IVF050060	Center-well	IVF-Specialized Center-well Culture Dish	Non-treated	Y	10	600
IVF050035	35mm, Flat bottom	IVF-Specialized 35 mm Culture Dish	Non-treated	Y	10	960
IVF051060	60mm, Flat bottom	IVF-Specialized 60 mm Culture Dish	Non-treated	Y	10	600
IVF050090	90mm, Flat bottom	IVF-Specialized 90 mm Culture Dish	Non-treated	Y	10	500
IVF041004	Four-well plate	IVF-Specialized Four-well Culture Plate	Non-treated	Y	1	100



Stock Code: 688026

Others

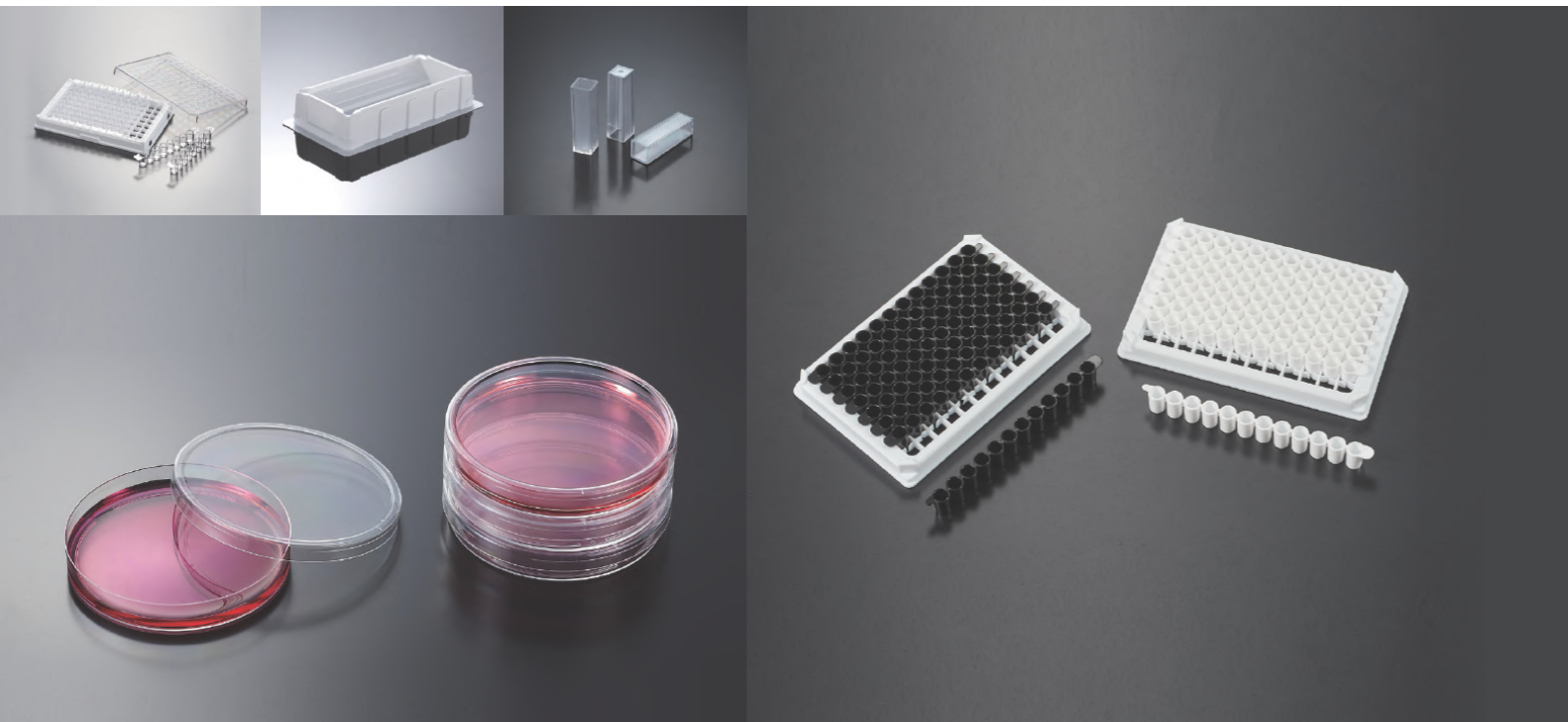

In addition to biolaboratory consumables for cell culture, liquid handling and filtration, JET BIOFIL also provides more convenient and commonly used experimental instruments and consumables for laboratories, including cuvettes, Petri dishes, loops, reservoirs, etc.

ELISA Plates

ELISA plates are an important tool for ELISA (enzyme-linked immunosorbent assay) experiments and are made of polystyrene (PS). Antigens, antibodies and biomolecules bind to the bottom surface of the plate by means of hydrophobic and ionic bonds.

The ELISA plates by Jet Biofil are made with international advanced surface treatment technologies and manufacturing processes for polymers, and show stable protein-binding properties. They can be used as safe, reliable and effective carriers during ELISA experiments, and in conjunction with immune and genetically modified products, as well as for clinical diagnosis.

- Specification: 96-well non-removable plate, 96-well/48-well removable plate (fitted with 8-well strip or 12-well strip)
- Binding force: High binding force Moderate binding force
- Materials: Polystyrene (PS) and high impact polystyrene (HIPS) , conforming to USP Class VI standards



Features

- Unique surface treatment process for higher protein adsorption properties
- 2 binding forces available: High binding force (300–400 ng/cm²), and moderate binding force (200–300 ng/cm²)
- 8-well and 12-well strips are provided to match the ELISA plates and for better cost-effectiveness
- Designed with a flat bottom and divided into removable and non-removable structures to satisfy different experimental applications
- Even well diameter and thickness, ensuring high experimental accuracy and repeatability
- Transparent plate, with a CV value <5%, higher and measurement flexibility; widely used in colorimetric determination
- Clearly marked with letters and numbers to distinguish the samples in different wells
- Dimensions conform to SBS international standards and are compatible with most brands of ELISA equipment
- Sterilized and non-sterilized available, sterilized by irradiation to SAL 10⁻⁶
- DNase/RNase-free, non-pyrogenic

High binding force ELISA plate

The plate undergoes surface treatment to increase the protein binding force to up to 300–400 ng/cm² (IgG); molecular weight of binding proteins: >10kD. This type of ELISA plates can improve sensitivity and reduce coat protein concentration and usage. If absent, the non-ionic detergent will fail to block the binding protein, and nonspecific reactions could occur, meaning the protein would need to be used as a blocking agent.

Moderate binding force ELISA plate

The ELISA plate binds with proteins through hydrophobic bonds on the surface and is suitable for use as a solid phase carrier for macromolecule proteins with a molecular weight >20kD. These plates have a protein binding capability of 200–300 ng /cm² (IgG). As the ELISA plate binds only with macromolecules, it is also suitable as a solid phase carrier for unpurified antibodies or antigens. Proteins or non-ionic detergents can be used as blocking liquid on these plates.

Type of ELISA Plate	Transmittance Variation (CV)	Binding Action	Sample Characteristics	Recommended Blocking Agent
High binding force plate 300–400 ng/cm ² (IgG)	<5.00%	Hydrophobic bond	Middle/macromolecular protein with positive charge >10kD	PBS containing 0.3% Tween 20, combination of 0.05% Tween 20 and 1%BSA
Moderate binding force plate 200–300 ng/cm ² (IgG)		Hydrophobic bond/ionic bond	Macromolecular protein >20KD	Tween 20 detergent used in combination with protein, BSA, skim milk and serum

Removable Stripes

Cat. No.	Specification	Binding Capacity	Description	Sterile	Qty.Per Bag(Box)	Qty.Per Case
FEP100012	12-well strip	High Binding	Flat Bottom (Fit with Removable Plate Frame)	Y	40	1600
FEP100008	8-well strip	High Binding		Y	60	2400
FEP200012	12-well strip	Medium Binding		N	40	1600
FEP200008	8-well strip	Medium Binding		N	60	2400

Removable Stripes

Cat. No.	Specification	Binding Capacity	Description	Sterile	Qty.Per Bag(Box)	Qty.Per Case
FEP100096	96-well	High Binding	Fixed flat bottom	Y	10	200
FEP111096	96-well	High Binding	Fixed flat bottom, with top	Y	10	200
FEP101896	96-well	High Binding	Detachable flat bottom, with 8×12 strips	Y	10	200
FEP101296	96-well	High Binding	Detachable flat bottom, with 12×8 strips	Y	10	200
FEP200096	96-well	Medium Binding	Fixed flat bottom	N	10	200
FEP201896	96-well	Medium Binding	Detachable flat bottom, with 8×12 strips	N	10	200
FEP201296	96-well	Medium Binding	Detachable flat bottom, with 12×8 strips	N	10	200

Immuno Micro Plates

The opaque multiple plates are made of polystyrene (PS) and have outstanding binding characteristics, making them the ideal choice for colorimetric determination. These opaque plates are suitable for fluorescence and luminescence tests, with the black immuno-micro plate usually used for fluorescence experiments. The opaque black surface reduces background interference from auto fluorescence, inter-well interference, and "light scattering", providing improved sensitivity. The white opaque immuno-micro plate is perfect for quantitative determination of bioluminescence or in other luminescence experiments. The immuno-micro plates support fast or continuous luminescence, providing improved measurement sensitivity.

- Specification: 96-well detachable plate (with 8/12-well strip tubes)
- Color: White Black
- Materials: Polystyrene (PS) and High impact polystyrene (HIPS), conforming to USP Class VI standards

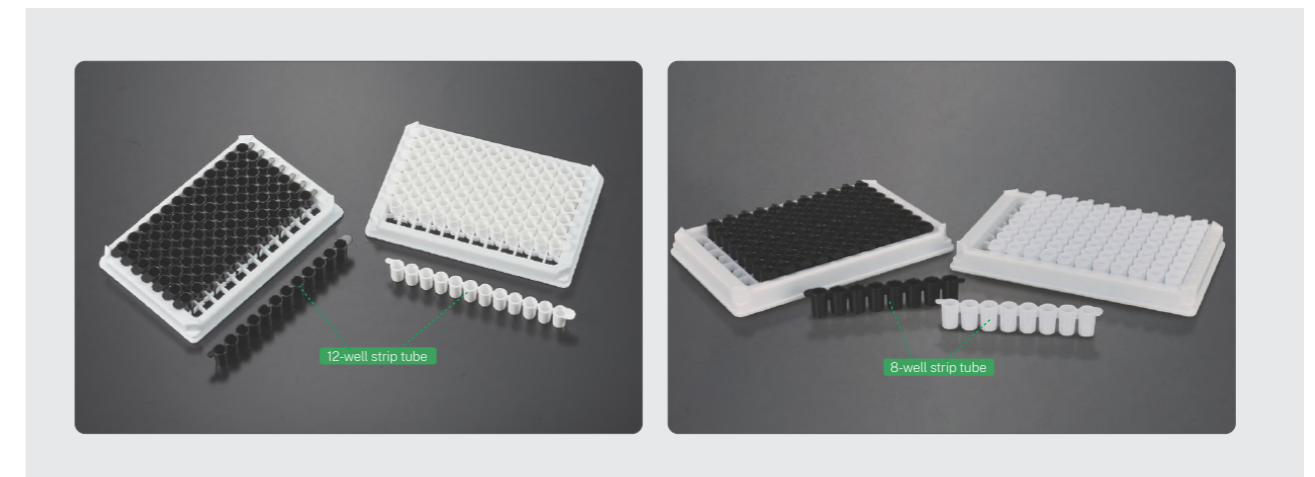

Features

- Available in white and black to satisfy the requirements of different experiments
- 8-well or 12-well strip tube for flexible selection based on samples
- Coordinated location of alphanumeric markings to facilitate operation and identification
- Good compatibility, suitable for use with most types of equipment
- Easy to use: Single-well operation as easy as row operation; compatible with all common instruments
- White immuno-micro plates reflect the light from luminescence reactions, ensuring reduced cross-contamination and low background effect
- The opaque black plate can reduce the background effect caused by auto-fluorescence and inter-well interference
- DNase/RNase-free, non-pyrogenic

Cat. No.	Well Qty.	Bottom	Specification	Color	Qty.Per Bag	Qty.Per Case
LTP010296	96	Detachable	12-well strip x 8	White	10	200
LTP010896	96	Detachable	8-well strip x 12	White	10	200
LTP021296	96	Detachable	12-well strip x 8	Black	10	200
LTP021896	96	Detachable	8-well strip x 12	Black	10	200

Petri Dishes

The petri dishes are one of the most basic lab items and are used frequently in the field of microbiology. Petri dishes have a wide range of applications, including inoculation, streaking and bacterial separation.

- Specification: 3.5 cm 6.0 cm 7.0 cm 9.0 cm 10.0 cm 15 cm
- Materials: Polystyrene (PS), conforming to USP Class VI standards

Features

- Different specifications available for a variety of specific lab requirements and demands
- Made of top-quality polystyrene, with even thickness and a smooth surface
- High transparency, facilitating optical observation
- Light and easy to hold for simple laboratory operation
- Sterilized by irradiation, SAL 10⁻⁶, SAL 10⁻³
- DNase/RNase-free, non-pyrogenic

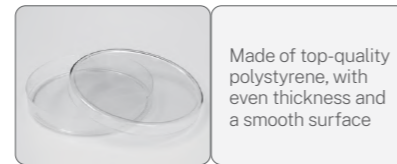
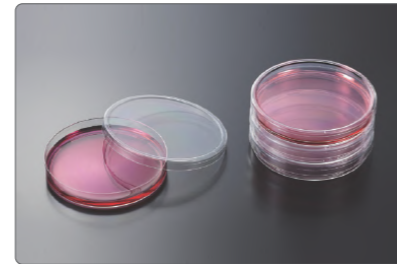

Made of top-quality polystyrene, with even thickness and a smooth surface

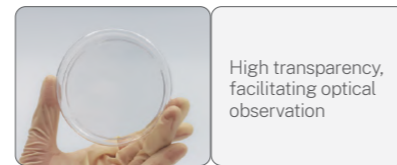

High transparency, facilitating optical observation

Inoculating Loops and Needles

Inoculating loops and needles are a common laboratory tool used in microbiological testing. JET BIOFIL inoculating loops and inoculating needles are made of polymer material polypropylene (PP), and feature a treated, hydrophilic surface.

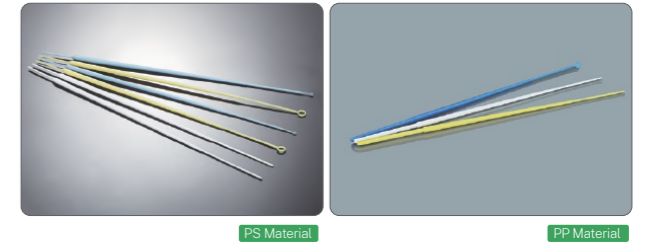

- Materials: Polypropylene(PP) / Polystyrene(PS)
Conforming to USP Class VI standards

Features

- Hydrophilic surface
- Available in a variety of colors to distinguish loops and needles of different specifications: white 1.0 µL inoculation needle, blue 10.0 µL inoculation loop, in line with the semi-quantitative standards of the processed sample
- Combination of inoculating loop and needle provides a dual-purpose function
- The inoculation needle shaft is slender and flexible, bendable, and can be used in narrow or special shaped containers
- Smooth ring edges to avoid damage to the medium surface
- Sterilized and non-sterilized available, sterilized by irradiation to SAL 10⁻⁶
- DNase/RNase-free, non-pyrogenic

Cat. No.	Volume (µL)	Length (mm)	Volume (µL)	Length (mm)	Color	Sterile	Qty. Per Bag	Qty. Per Case
DIL101001	1.0	228	1.0	228	Blue	Y	25	2000
DIL112001	1.0	228	1.0	228	Blue	Y	1	3000
DIL211001	1.0	228	1.0	228	Blue	Y	10	12000
DIL212001	1.0	228	1.0	228	Blue	Y	10	2000
DIL101010	10.0	228	10.0	228	Yellow	Y	25	2000
DIL112010	10.0	228	10.0	228	Yellow	Y	1	3000
DIL211010	10.0	228	10.0	228	Yellow	Y	10	12000
DIL212010	10.0	228	10.0	228	Yellow	Y	10	2000
DIL220001	-	228	-	228	White	Y	25	2000
DIL222001	-	228	-	228	White	Y	1	3000
DIL221001	-	228	-	228	White	Y	10	12000
DIL223001	-	228	-	228	White	Y	10	2000
DIL010001	1.0	218	1.0	218	White	N	20	2000
DIL011001	1.0	218	1.0	218	White	Y	20	2000
DIL111001	1.0	219	1.0	219	White	Y	1	3000
DIL010010	10.0	220	10.0	220	Blue	N	20	2000
DIL011010	10.0	220	10.0	220	Blue	Y	20	2000
DIL111010	10.0	220	10.0	220	Blue	Y	1	3000
DIL020001	-	218	-	218	Yellow	N	20	2000
DIL021001	-	218	-	218	Yellow	Y	20	2000
DIL121001	-	218	-	218	Yellow	Y	1	3000

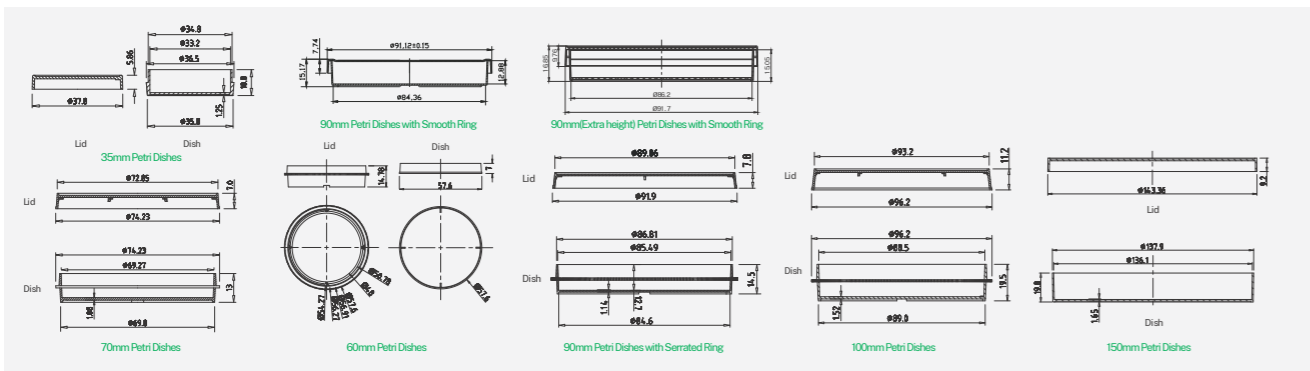

Petri Dishes with Serrated Ring

Cat. No.	Diameter (cm)	Height (mm)	Growth Area (cm ²)	Dish Weight (g)	SAL	Qty. Per Bag	Qty. Per Case
MCD000060	6.0	17.3	21.2	8.79	10 ⁻⁶	10	600
MCD000070	7.0	15.5	36.3	13.74	10 ⁻⁶	10	600
MCD000090	9.0	16.9	55.0	20.85	10 ⁻⁶	10	500
MCD000100	10.0	22.6	60.8	29.45	10 ⁻⁶	10	300

Petri Dishes with Smooth Ring

Cat. No.	Diameter (cm)	Height (mm)	Growth Area (cm ²)	Dish Weight (g)	SAL	Qty. Per Bag	Qty. Per Case
MCD000035	3.5	12.6	8.5	4.11	10 ⁻⁶	10	960
MCD110090	9.0	15.2	55.0	12.99	10 ⁻⁶	20	500
MCD111090	9.0	15.2	55.0	12.99	10 ⁻⁶	10	500
MCD100090	9.0	15.2	55.0	12.99	10 ⁻³	20	500
MCD300090	9.0(Extra height)	16.9	58.3	15.05	10 ⁻³	20	500
MCD310090	9.0(Extra height)	16.9	58.3	15.05	10 ⁻⁶	20	500
MCD000150	15.0	22.7	143.0	60.76	10 ⁻⁶	1	120
MCD100150	15.0	22.7	143.0	60.76	10 ⁻⁶	5	100

Height: total height that combines cap and dish

Cuvettes

Cuvettes are a common consumable in spectral laboratory analysis. The JET BIOFIL cuvettes are made of transparent polymer, polystyrene (PS), for its good chemical compatibility, and can be used for optical determination of most polar organic solutions, weak acidic solutions and weak alkaline solutions.

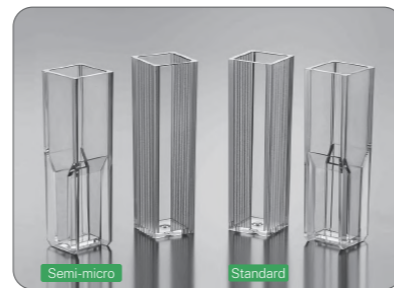

- Materials: Polystyrene (PS), conforming to USP Class VI standards

Features

- Available as standard type and semi-micro type (spectral range: 400 nm to 800 nm, optical path: 10 mm)
- Made of high-quality optical plastic with good chemical compatibility
- Thanks to precision optical processing technology, the optical performance error of the light transmission surface is $\leq 0.3\%$
- Recessed window reduces the risk of scratches during use
- Matte surface provides an ideal labelling and operating area
- The semi-micro cuvette is marked with a light path arrow to ensure the consistency of projection direction

Cat. No.	Type	Volume (mL)	Recommended Working Capacity (mL)	Optical Path (mm)	Optical Windows (piece)	Sterile	Qty. Per Box	Qty. Per Case
CUV010015	Semi-micro	1.50	1-2.5	10	2	N	100	1000
CUV010045	Standard	4.50	3-4	10	2	N	100	1000

Graduated Urine Centrifuge Tubes

Graduated urine centrifuge tubes are mainly used for collecting and storing urine samples.



- Specification: 15 mL
- Materials: Polystyrene (PS), conforming to USP Class VI standards

Features

- Smooth and transparent tube with clear and accurate scale
- Maximum RCF: 1,500×g
- Passed rigorous leakage test
- DNase/RNase-free, non-pyrogenic

Cat. No.	Volume (mL)	Description	RCF(xg)	Sterile	Qty. Per Bag	Qty. Per Case
CFT418150	15	PS, plug seal cap	1500	N	1000	1000
CFT419150	15	PS, without cap	1500	N	100	1000
CFT420150	15	Graduated urine centrifuge cap	-	N	500	1000

Latex Powder-free Gloves

These disposable examination gloves are used extensively in biological and medical experiments and examinations to not only protect the operators' hands, but also to prevent hand contamination due to contact.



- Specification: XS, S, M and L
- Materials: Latex

Features

- Disposable latex examination gloves, powder-free, non-sterile
- Natural latex, high protection and flexibility in one
- High tensile strength, not easy to break, reduces glove loss
- Superior coating technology – the coating does not fall off easily, blocks allergic factors, reduces sensitivity and enhances wearing comfort

Cat. No.	Product Description	Color	Sterile	Size	Weight(g)	Qty. Per Box	Qty. Per Case
GVL100101	Latex, powder-free, coating technology, fully textured	White	N	L	5.8	100	1000
GVM100102	Latex, powder-free, coating technology, fully textured	White	N	M	5.8	100	1000
GVS100103	Latex, powder-free, coating technology, fully textured	White	N	S	5.8	100	1000
GVS100104	Latex, powder-free, coating technology, fully textured	White	N	XS	5.8	100	1000
GVL110101	Latex, powder-free, coating technology, fully textured	Light Yellow	Y	L	5.8	100	1000
GVM110102	Latex, powder-free, coating technology, fully textured	Light Yellow	Y	M	5.8	100	1000
GVS110103	Latex, powder-free, coating technology, fully textured	Light Yellow	Y	S	5.8	100	1000
GVS110104	Latex, powder-free, coating technology, fully textured	Light Yellow	Y	XS	5.8	100	1000

NBR Gloves

NBR gloves are used extensively in biological and medical experiments and examinations. They are the first choice for a variety of different experiments, as well as detailed inspections and examinations, as they provide a better fit while supporting more flexible operations. Hypoallergenic.



- Specification: XS, S, M and L
- Materials: Nitrile butadiene rubber (NBR)

Features

- Disposable NBR examination gloves, powder-free and non-sterile
- Thin and hypoallergenic, contain no allergenic latex proteins
- High degree of protection against acids, alkalis, oils and chemicals
- Tough and elastic with good impermeability
- Thin and flexible, able to improve sense of touch for both hands, economical and practical

Cat. No.	Product Description	Color	Size	Weight (g)	Qty. Per Box	Qty. Per Case
GVL200101	Butyronitrile, powder-free, rubber and fingertip textured surface	Blue	L	3.5	100	1000
GVM200102	Butyronitrile, powder-free, rubber and fingertip textured surface	Blue	M	3.5	100	1000
GVS200103	Butyronitrile, powder-free, rubber and fingertip textured surface	Blue	S	3.5	100	1000
GVS200104	Butyronitrile, powder-free, rubber and fingertip textured surface	Blue	XS	3.5	100	1000



Disposable sampling tube

- Made of high-quality polypropylene (PP), the tube body is transparent with no scale, has good visibility, and can stand on the bottom
- It is designed with a conical bottom so that it is easy to pour and minimizes residue
- Spiral seal with a unique structural design and manufacturing process prevents liquid leakage
- The size complies with the Technical Specifications for Detection of 2019-nCoV With Mixed Collection

Preservation solution

- Purple preservation solution for easy observation and identification
- Inactivated type without guanidine salt effectively preserves RNA and protects medical personnel
- No RNA ase, no DNA ase and no endotoxin
- Transport and store at room temperature; the pH value of the sample preservation solution is 9 ± 0.5 at 25°C

Sampling throat swab

- The high-quality flocked swab facilitates rapid sampling and release
- The disposable throat swab is easy to handle and break with no debris

Storage conditions : Store indoors; Shelf life: 18 months
 Sample storage: 3 days at 37°C , 1 week at 25°C , 1 month at 4°C , long-term storage below -20°C

Cat. No.	Product Description	Package
CY1003010	10 mL sampling tube (10-in-1 standard tube) + 6 mL preservation solution, sterile	50 Pcs/Box, 24box/Carton
CY1002010	10 mL sampling tube (10-in-1 standard tube) + 6 mL preservation solution, sterile; Sampling throat swab, non-sterile	50 Pcs/Box, 1200 Pcs/Carton
CY1003030	30 mL sampling tube (20-in-1 standard tube) + 11-12 mL preservation solution, sterile	20 Pcs/Box, 24 Box/Carton
CYS001001	Sampling throat swab	50 Pcs/Box, 9600 Pcs/carton
CYS001002	Sampling throat swab	100 Pcs/Box, 6000 Pcs/carton
CYS011001	Sampling throat swab (Single Packed)	100 Pcs/Bag, 500 Pcs/Box, 2000 Pcs/Carton

Disposable Virus Sampling Tubes (Medical Device)

A disposable virus sampling tube is composed of a throat swab and a tube containing preservation solution. It can be used for sampling, transportation and storage of virus samples. The disposable virus sampling tube of Jet Bio-Filtration Co., Ltd. complies with the "Technical Specifications for Detection of 2019-nCoV Nucleic Acids with 10 in 1 Mixed Collection" and "Technical Specifications for Detection of 2019-nCoV Nucleic Acids with 20-in-1 Mixed Collection", and is suitable for large-scale 2019-nCoV screening.

[Medical Device Registration Certificate No./Product Technical Requirements No.]: YSXB No. 20201245

[Medical Device Production Registration Certificate No.]: YSSYJXSCB No. 20200254

- Specification: 10 Samples in 1 Tube, 20 Samples in 1 Tube
- Packaging: Box, Carton
- Materials: Tube Body: Polypropylene (PP) Tube Cap: High-Density Polyethylene(PE)



Stock Code: 688026

Biological Reagents



Committed to providing innovative solutions and premier services, and maximizing customer value, JET BIOFIL also provides a variety of high-quality and high-stability culture media, serums and supplementary reagent products in addition to consumables to help you obtain reproducible and successful research results every day.

Fetal Bovine Serum

Fetal Bovine Serum (FBS) is a light yellow, clear, non-hemolytic, foreign body-free, slightly viscous liquid. It is commonly added to cell culture media to promote and maintain the growth of cells of vertebrates, mammals, insects and other species. The FBS produced by Jet Bio-Filtration Co., Ltd is prepared from the blood of 8-month-old fetal calves of healthy pregnant cows, which is aseptically collected, separated and filtered. The product has high nutrient content, no mycoplasma, no bovine virus and no bacteriophage, and an endotoxin content less than 1 EU/mL. It is suitable for cell, tissue and organ culture, cell line preservation, and monoclonal antibody development, and is one of the preferred media used by hospitals, scientific research institutions, and vaccine and biopharmaceutical manufacturers.

- Blood origin: Uruguay, China
- Origin: Guangzhou China
- Specifications: 100 mL, 500 mL
- Storage conditions: -15°C—20°C
- Shelf life: 5 years



Features

- The FBS of Jet Bio-Filtration Co., Ltd. is produced with strictly screened raw materials from selected high-quality, nationally approved blood origins in the world (Uruguay and China)
- The blood source is stable without cattle disease epidemic within 2 years. The source of serum is traceable, including the health of the mother cow.
- Strictly controlled production environment: standard cleanrooms, filling in Class 100 local clean environments, low temperature control system.
- International advanced production technology and 0.1 μm filtration three times help achieve stable product performance and little difference between batches.
- With complete test indexes, the product has high nutrient content, no mycoplasma, no bovine virus, no bacteriophage, and an endotoxin content less than 1 EU/mL.

The birth of a bottle of fetal bovine serum

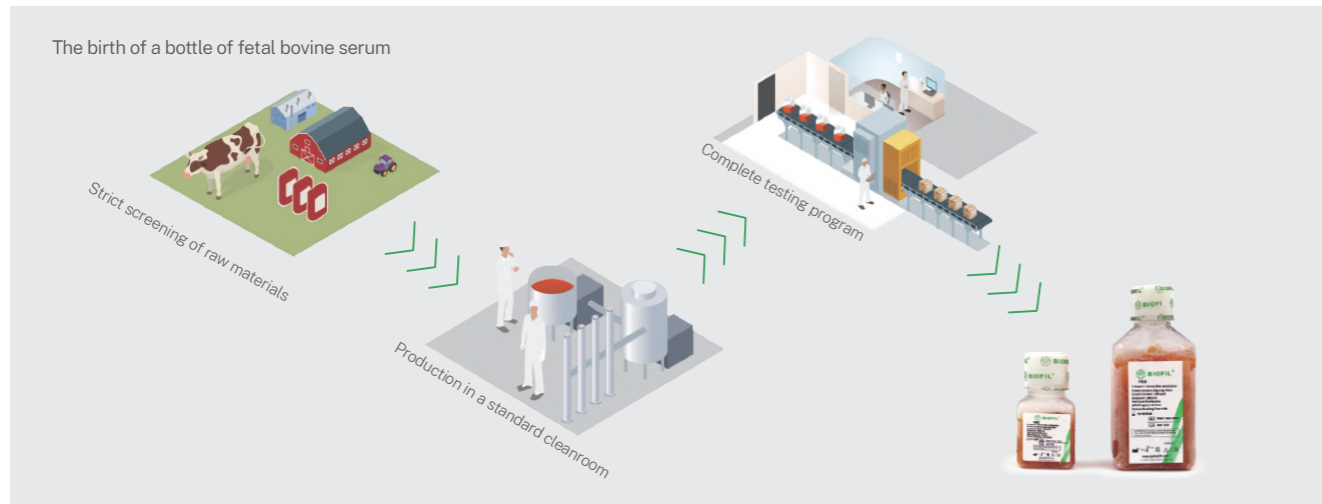

Confirmation Projects

Project	Quality Standard	Test Result	Project	Quality Standard	Test Result
Appearance	Light yellow, clear and transparent	Light yellow, clear and transparent	Sterility test	Negative	Negative
PH value	7.00-8.50	7.97	Mycoplasma	Negative	Negative
Protein content (g/L)	30-40	38.7	Coliphage	Negative	Negative
Endotoxin (Eu/ml)	≤5	≤5	Maximum proliferative concentration	≥10 ⁶ /ml	1.6x10 ⁶ /ml
Hemoglobin (m/L)	≤200	140.4	Cell doubling time	Not more than 20h	17.8h
Osmotic pressure (mOs mol/kg)	250-330	287	Cell cloning rate	Not less than 70%	83.50%

Viral Testing

All virus test results should be negative	Bovine diarrhea virus (BVDV)	Bovine adenovirus (BAV-3)	Bovine parvovirus (BPV)	Reovirus (RE0-3)	Bovine parainfluenza virus (PI-3)
	Negative	Negative	Negative	Negative	Negative
Storage conditions and validity period	-15°C to -20°C; valid for 5 years from the date of production.				

Cat. No.	Description	Volume (mL)	Pcs/Carton
FBS111025	Imported fetal bovine serum	25	50
FBS110100		100	50
FBS111500		500	20
FBS100025	Domestic fetal bovine serum	25	84
FBS100100		100	84
FBS101500		500	20
FBS130100	Imported newborn bovine serum	100	50
FBS131500		500	20

Media

A variety of different liquid cell culture mediums are provided by Jet Bio-Filtration Co., Ltd. to meet the needs of daily experiments.



RPMI-1640 culture liquid RPM101640

It is currently a widely used medium in the culture of mammalian and special hematopoietic cells, normal or malignant hyperplastic leukocytes and hybridoma cells. It is mainly used for suspension cell culture.

- * [+]2.0 g/L Glucose [+]2.0 g/L NaHCO₃ [+]3.0 g/L HEPEs [+]2 mM L-Glutamine
- * 500 mL/bottle, 20 bottles/carton
- * Storage conditions: 2-8°C

DMEM high glucose DME101500

It is a widely used medium that can be used for many mammalian cell cultures and is more suitable for high-density suspension cell culture. It is suitable for the culture of clones with poor adhesion in which detachment from the original growth point is not desired, and can also be used for culturing hybridoma cells and DNA transfected transformed cells.

- * [+]4.5 g/L Glucose [+]2.5 g/L NaHCO₃ [+]0.11 g/L Sodium Pyruvate [+]3.0 g/L HEPEs [+]2 mM L-Glutamine
- * 500 mL/bottle, 20 bottles/carton
- * Storage conditions: 2-8°C

DMEM low glucose DME102500

It is a widely used medium for many mammalian cell cultures. Low glucose medium is suitable for anchorage-dependent cell culture, especially for tumor cell culture with fast growth rate and poor adhesion.

- * [+]1.0 g/L Glucose [+]2.5 g/L NaHCO₃ [+]0.11 g/L Sodium Pyruvate [+]3.0 g/L HEPEs [+]2 mM L-Glutamine
- * 500 mL/bottle, 20 bottles/carton
- * Storage conditions: 2-8°C

DMEM/F12 DME103500

F12 medium has a complex composition and contains a variety of trace elements. It is combined with DMEM in a 1:1 ratio to form the DMEM/F12 Medium. As the basis for the development of a serum-free formula, it is suitable for mammalian cell culture under low-serum conditions by taking advantage of the richer ingredients in F12 and the higher concentration of nutrients in DMEM. At present, DMEM/F12 is widely used in the basal culture of MDCK cells, neurogliaocytes, fibroblasts, endothelial cells, rat fibroblasts and many other mammalian cells. At the same time, this medium is very suitable for clonal density culture, and has been widely used in the study of the effects of various hormones and growth factors in target tissues.

- * [+]3.15 g/L Glucose [+]Pyridoxine Hydrochloride [+]1.2 g/L NaHCO₃ [+]3.0 g/L HEPEs [+]2 mM L-Glutamine
- * 500 mL/bottle, 20 bottles/carton
- * Storage conditions: 2-8°C

MEM MEM100500

MEM, the minimum essential medium, contains only 12 essential amino acids, glutamine and 8 vitamins, and is suitable for the growth of a variety of cell monolayers. It can be widely used for the culture of various established cell lines and mammalian cell types in different places. MEM is suitable for cell culture work in some special research because it is easy to add or reduce certain components.

- * [+]Earle's balanced salt [+]1.0 g/L Glucose [+]2.2 g/L NaHCO₃ [+]3.0 g/L HEPEs [+]2 mM L-Glutamine

* 500 mL/bottle, 20 bottles/carton
 * Storage conditions: 2-8°C

IMDM IMD100500

The culture liquid contains selenium, additional amino acids and vitamins, sodium pyruvate and HEPEs, and contains potassium nitrate in place of ferric nitrate. IMDM is a liquid rich in nutrients that can promote the growth of mouse B lymphocytes, LPS-stimulated B cells, bone marrow hematopoietic cells, T cells and lymphoma cells, and can also be used for rapid proliferation of high density cells.

* [+] 4.5 g/L Glucose [+] 3.0 g/L NaHCO_3 [+] 3.0 g/L HEPEs [+] 2 mM L-Glutamine

* 500 mL/bottle, 20 bottles/carton

* Storage conditions: 2-8°C

McCoy's 5A MCS100500

It is mainly designed for the culture of sarcoma cells, and can support the growth of a variety of primary grafts (such as bone marrow, skin, lung and spleen, etc.). In addition to culture of general primary cells, it is mainly used for tissue biopsy culture, some lymphocyte cultures, and as the growth support of some difficult-to-culture cells, such as Jensen rat sarcoma fibroblasts, human lymphocytes, HT-29, BHL-100 and other epithelial cells.

* [+] Tryptone [+] 3.0 g/L Glucose [+] 2.2 g/L NaHCO_3 [+] 3.0 g/L HEPEs [+] 2 mM L-Glutamine

* Storage conditions: 2-8°C

* 500 mL/bottle, 24 bottles/carton

Supplementary Reagents

Jet Bio-Filtration provides a wide range of high quality supplementary cell culture reagents, including PBS buffer, pancreatin, double antibodies, etc., to meet the needs of daily experiments.



PBS 1X PBS000001

PBS (phosphate buffered saline, 0.01M) maintains the pH range (PH 7.2-7.4) required by tissues and cells, and is widely used in cell culture applications, such as washing cells, dilution of cells and preparation of reagents during cell counting, etc.

Main ingredients: 3.49 g/L $\text{Na}_2\text{HPO}_4 \cdot 12\text{H}_2\text{O}$; 0.2 g/L KH_2PO_4 ; 0.2 g/L KCl

* [-] Calcium [-] Magnesium [-] Phenol Red

* Storage conditions: 2-8°C

Pancreatin PCT000500 /PCT000100

It is widely used for dissociation of tissues and monolayer cells.

* 0.25% Trypsin-0.02%EDTA

* Storage conditions:-20°C

Double antibiotic (penicillin-streptomycin mixture) 100X/500X

* 100mL, double antibiotic (penicillin-streptomycin mixture) 100X

* 500mL, double antibiotic (penicillin-streptomycin mixture) 500X

* Storage conditions:-20°C

Insect Media

McCoy's 5A MCS100500 is mainly designed for the culture of sarcoma cells.

TC-100 TC-100500 is suitable for culturing most lepidopteran cell lines.



TC-100 TC-100500

This insect culture medium has a pH value of 6.0-6.4 and osmotic pressure of 345-380 mOsm/kg, and is suitable for culturing most lepidopteran cell lines.

* [+] 1.0 g/L Glucose [+] 0.5 g/L HEPEs [+] 0.35 g/L NaHCO_3 [+] 2 mM L-Glutamine

* Storage conditions: 2-8°C

* 500 mL/bottle, 24 bottles/carton

Cat. No.	Description	Package
PBS000001	PBS 1X, Storage conditions: 2-8°C	500 mL/bottle, 20 bottles/carton
PCT000500	Trypsin-EDTA (0.25%, calcium/magnesium-free, phenol red), Storage conditions:-20°C	500 mL/bottle, 20 bottles/carton
PCT100500	Trypsin (EDTA-free, calcium/magnesium-free, phenol red), Storage conditions:-20°C	500 mL/bottle, 20 bottles/carton
PCT000100	Trypsin-EDTA (0.25%, calcium/magnesium-free, phenol red) Storage conditions:-20°C	100 mL/bottle, 30 bottles/carton
DAB000100	100mL, double antibody (penicillin-streptomycin mixture) 100X, Storage conditions:-20°C	15 PCs/box, 30 PCs/carton
DAB000500	500mL, double antibody (penicillin-streptomycin mixture) 500X, Storage conditions:-20°C	20 PCs/carton

Laboratory Equipment



JET BIOFIL laboratory equipment includes laboratory water systems (Puro, Geno, Alto, and Pico), CO₂ incubators, laboratory instruments (microcentrifuges, mixers, magnetic stirrers, multifunctional shakers, etc.), automated nucleic acid extraction workstations, biosafety cabinets, etc.

	Mini Centrifuge M1006	The Smart Personal Centrifuge M1008	Doctor Centrifuge with Microprocessor & Brushless Motor D1006
Centrifuge series			
	High Speed Micro Centrifuge with Microprocessor & Brushless Motor D1018	High Speed Micro Centrifuge with Microprocessor & Brushless Motor D1012	Doctor Centrifuge with Microprocessor & Brushless Motor M1003S
	The Table Top Genius with Microprocessor & Brushless Motor M1012P	High-Speed Micro (Freezing) Centrifuge D1016R	Desktop High-Speed Microcentrifuge D1016
Shakers			
	Digital 3D Shaker with Microprocessor & Brushless Motor SK 3D-5	4-Plate Shaker (up to 4 Microplates) SK Quattro	30 mm-70 mm Diameter, Orbital / Linear motion SK 15
	10 mm / 20 mm Diameter, Orbital / Linear motion SK 10/SK 20	Microwell Plate Shaker SK18M	
Mixers			
	Blood Tube Rotator DR 16	Digital Multi-Tube Vortexer with Microprocessor & Brushless Motor VM25 D	Digital Vortex Mixer with Microprocessor & Brushless Motor VM 42 D

Mixers



Digital Vortex Mixer with Microprocessor & Brushless Motor VM 28



Fixed Speed Blood Roller Mixer TR 4D

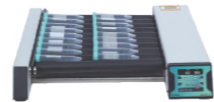

Digital Tube Roller with Microprocessor & Brushless Motor TR 6D/TR 10D



Mini Vortex Mixer with Brushless Motor VM 45MVM 45



Blood Tube Rotator DR 24

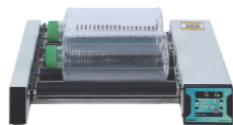

Digital Bottle Roller TR3D/TR5D

Micro Pipettes



JetPip™ Plus



Dispenser



JetPip™ Pipette Controller



Micro Volume Pipettes



Multichannel Micro Pipettes

Stirrer series



5 / 10 / 15 Station Heated Magnetic Stirrer with Microprocessor & Brushless Motor MS HP5M/MS HP10M/MS HP15M



Multistation Motorless Ultra Thin Magnetic Stirrer MS 5M/MS 10M/MS 15M



Motorless Slim Magnetic Stirrer MS Uno

Stirrer series



Multistation Motorless Ultra Thin Magnetic Stirrer MS 4M



Magnetic stirrer MS 2SL/MS 50L/MS-200L



Hot Plate Magnetic Stirrer MS HP550D



Hot Plate Magnetic Stirrer MS HP320D

Laboratory Water



Pure Water For Your Laboratory-Pico



Alto Ultrapure Type (I) Water



Puro Primary Grade Type (III) Water



Duo Dual Quality Type II and Type I Water



Geno Laboratory Grade Type (II) Water

Cell@ 188 CO₂ Incubator



CO₂ Incubator

FASTER



biosafety cabinet

JetPip™ Plus

Features

- Intuitive and convenient speed adjustment simply done with the tips of your fingers
- Lightweight, well-balanced and ergonomic design that allows for fatigue-free pipetting
- Vibrant backlit LEDs provide optical feedback of the remaining battery life and speed settings
- Rechargeable lithium polymer battery offers long cordless runtime
- Smooth setting of pump speed
- Operation while recharging is possible
- Compatible with most plastic and glass pipettes from 0.1-100mL
- Powerful pump fills a 25mL pipette in <5 seconds
- Quick release of aspirating cone for easy exchange of membrane filters



Cat. No.	Voltage	Charger Type	Qty.Per Box
SPA410220	Universal	0.1-100mL	1

JetPip™ Pipette Controller

Pipette controllers are highly technical and precise assistive devices for common 1 to 100 ml plastic or glass pipets.

Features

- Light weight and cordless for convenient use. If handled correctly, the device itself will not come into contact with any liquid.
- The aspirating or dispensing speed of the pump can be controlled by the pump speed switch.
- Made with recyclable materials.
- Long life and environmentally friendly with up to 8 hours rechargeable continuous electric power.
- The filter with hydrophobic membrane provides contamination-free liquid handling.



Pipette Controller

Cat. No.	Voltage	Charger Type	Qty.Per Box
SPA001220	Universal	1.0-100.0 mL	1
SPA003220		1.0-100.0 mL	1
SPA004220		1.0-100.0 mL	1

Fittings

Cat. No.	Name	Charger Type	Qty.Per Box
SPA010020	Filter (0.20 µm hydrophobic membrane)	----	5
SPA010045	Filter (0.45 µm hydrophobic membrane)	----	5
SPA020220	Charger	USA	1
SPA030220	Charger	UK	1
SPA040220	Charger	EU	1

Multichannel Micro Pipettes

Features

- Soft, smart TPE fingergrip
- Easily removable & fully autoclavable manifold
- Manifold rotates 360° for easy right or left hand operation
- One-hand tip ejection
- Consistent sample loading
- Soft tip loading and ejection
- Leak-free sealing of tip
- Attractive color coding
- Compatible with most types of tips
- Calibration report enclosed with every pipette



8 Channel Micro Pipettes								
Cat. No.	Range (µL)	Increment (µL)	Measurement Volume (µL)	Accuracy		Precision		
				%	µL	%	µL	
SPA008050	5-50	0.5	50	1	0.5	0.7	0.35	
			25	1.50	0.375	1	0.5	
			5	3.00	0.15	2	0.1	
SPA008100	10-100	1	100	1.00	1	0.5	0.5	
			50	1.00	0.5	0.5	0.25	
			10	1.50	0.15	0.75	0.075	
SPA008200	20-200	1	200	0.70	1.4	0.25	0.5	
			100	1.00	1.0	0.4	0.4	
			20	1.50	0.3	0.75	0.15	
SPA008300	30-300	1	300	0.80	2.4	0.25	0.75	
			50	1.50	0.75	0.75	0.375	

12-Channel Micro Pipettes							
Cat. No.	Range (µL)	Increment (µL)	Measurement Volume (µL)	Accuracy		Precision	
				%	µL	%	µL
SPA012010	0.5-10	0.1	10	1.5	0.15	1.5	1.5
			5	2.5	0.125	2.5	0.125
			1	4	0.4	4	0.4
SPA012050	5-50	0.5	50	1	0.5	0.7	0.7
			25	1.5	0.375	1	0.25
			5	3	0.15	2	0.1
SPA012100	10-100	1	100	1.00	1	0.50	0.5
			50	1.00	0.5	0.50	0.25
			10	1.50	0.15	0.75	0.75
SPA012200	20-200	1	200	0.7	1.4	0.25	0.5
			100	1	1	0.4	0.4
			20	1.5	0.3	0.75	0.15
SPA012300	30-300	1	300	0.80	2.4	0.25	0.75
			150	1.00	1.5	0.50	0.75
			50	1.50	0.75	0.75	0.375

Variable Volume Pipette							
Cat. No.	Range (µL)	Increment (µL)	Measurement Volume (µL)	Accuracy		Precision	
				%	µL	%	µL
SPA200125	0.1-2.5	0.01	2.5	2.50	0.0625	1.60	0.04
			1.25	3.00	0.0375	3.00	0.0375
			0.25	12.00	0.03	6.00	0.015
SPA200510	0.5-10	0.1	10	1.00	0.1	0.80	0.08
			5	2.00	0.1	1.00	0.05
			1	2.50	0.025	1.50	0.015
SPA200220	2-20	0.5	20	0.90	0.18	0.40	0.08
			10	1.50	0.15	1.00	0.1
			2	3.00	0.06	2.00	0.04
SPA200550	5-50	1	50	0.60	0.3	0.30	0.15
			25	0.80	0.2	0.40	0.1
			5	2.00	0.1	2.00	0.1
SPA210100	10-100	0.5	100	0.80	0.8	0.15	0.15
			50	1.00	0.5	0.50	0.25
			10	3.00	0.3	1.50	0.15
SPA220200	20-200	1	200	0.60	1.2	0.15	0.3
			100	0.70	0.7	0.30	0.3
			20	2.00	0.4	0.80	0.16
SPA211000	100-1000	5	1000	0.60	6	0.20	2
			500	1.00	5	0.40	2
			100	2.00	2	0.70	0.7

Micro Volume Pipettes

Features

- Suitable for both left and right handed users, and offers a relaxed grip and good balance
- Light & smooth plunger action
- Fully autoclavable
- UV resistant
- Resistance-free click-stop counter
- Larger digits
- Ergonomic design ensuring light weight & soft plunger movement
- Easily accessible recalibration mechanism without any chance of accidental change in calibration
- Calibration conforms to DIN 12650 & EN-ISO 8655 standards, ensuring high accuracy & precision



Fixed Volume Pipette							
Cat. No.	Range (µL)	Increment (µL)	Measurement Volume (µL)	Accuracy		Precision	
				%	µL	%	µL
SPA100005	5	-	5	1.3	0.065	1.2	0.06
SPA100010	10	-	10	0.8	0.08	0.8	0.08
SPA100050	50	-	50	0.5	0.25	0.3	0.15
SPA100100	100	-	100	0.5	0.5	0.3	0.3
SPA100500	500	-	500	0.3	1.5	0.2	1.0
SPA101000	1000	-	1000	0.3	3.0	0.15	1.5

